



# TSW200



# HARDWARE

## FRONT VIEW

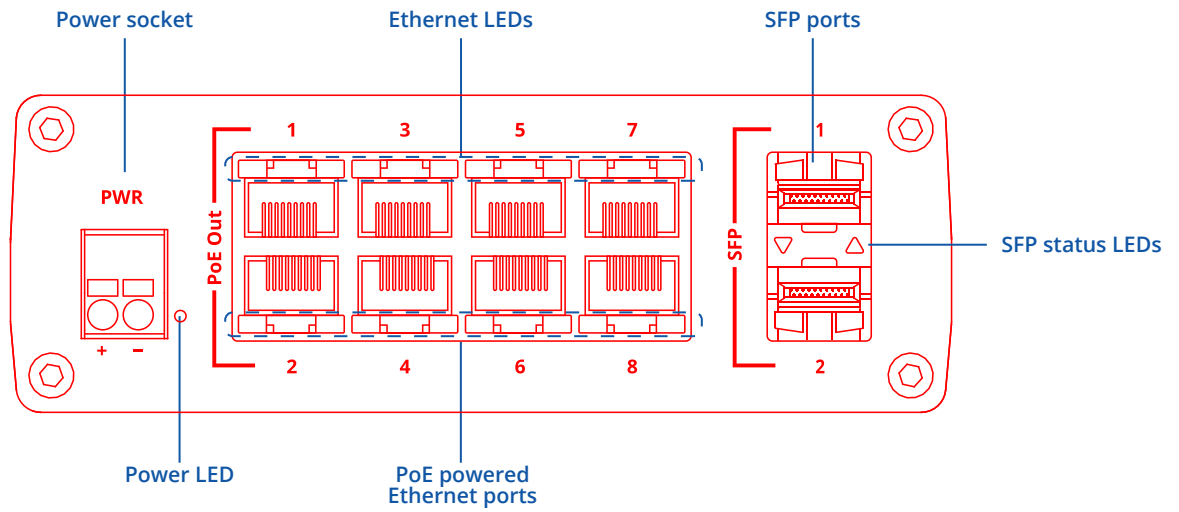

## BACK VIEW

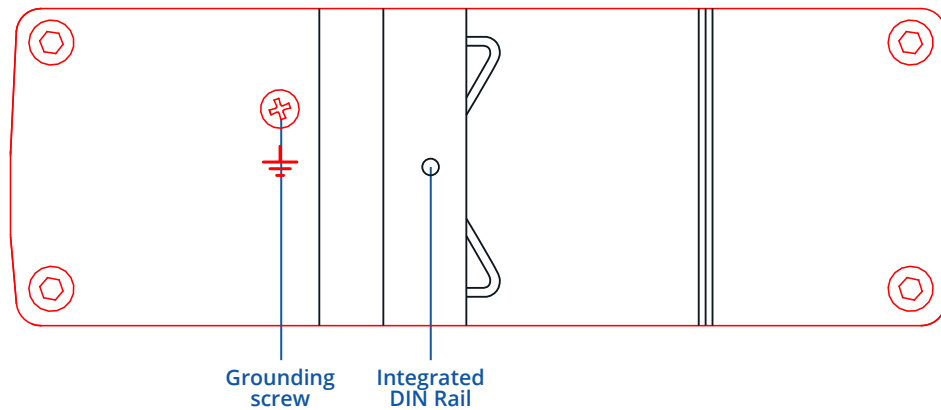

## RJ45 LED MEANING

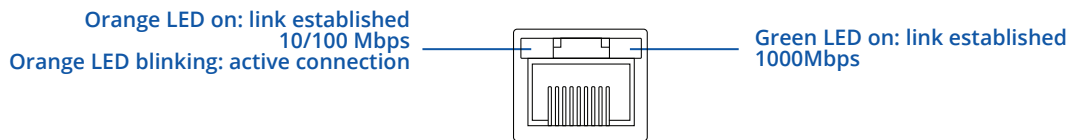

## POWER SOCKET PINOUT

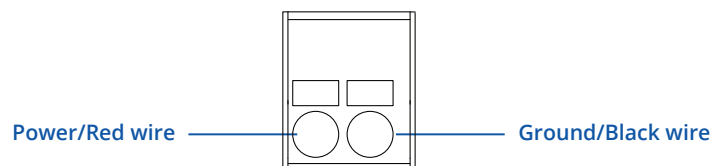

## FEATURES

### ETHERNET

LAN	8 x ETH ports, 10/100/1000 Mbps, supports auto MDI/MDIX crossover
Fiber	2 x SFP ports
IEEE 802.3 series standards	802.3i, 802.3u, 802.3ab, 802.3x, 802.3az

### POE

PoE ports	Port 1 - 8
PoE standards	802.3af and 802.3at
PoE Max Power per Port (at PSE)	30 W
Total PoE Power Budget (at PSE)	240 W

### PERFORMANCE SPECIFICATIONS

Bandwidth (Non-blocking)	20 Gbps
Packer buffer	128 KB
MAC address table size	2K entries
Jumbo frame support	9216 bytes

### POWER

Connector	2-pin industrial DC power socket
Input voltage range	7 – 57 VDC
PoE-out input voltage range	44 – 57 VDC
Power consumption	Idle: 1.81 W / Max: 5.5 W / PoE Max: 245.5 W

### PHYSICAL INTERFACES

Ethernet	8 x RJ45 ports, 10/100/1000 Mbps
Fiber	2 x SFP ports
Status LEDs	1 x Power LED, 16 x LAN status LEDs 2 x SFP status LEDs
Power	1 x 2-pin industrial DC power socket
Other	1 x Grounding screw

### PHYSICAL SPECIFICATION

Casing material	Full aluminum housing
Dimensions (W x H x D)	132 x 44.2 x 95.1 mm
Weight	517 g
Mounting options	DIN rail or wall mounting (additional kit needed), flat surface placement

### OPERATING ENVIRONMENT

Operating temperature	-40 °C to 75 °C
Operating humidity	10% to 90% non-condensing
Ingress Protection Rating	IP30

## WHAT'S IN THE BOX?

### STANDARD PACKAGE CONTAINS

- TSW200
- QSG (Quick Start Guide)
- Packaging box



## STANDARD ORDER CODES

PRODUCT CODE	HS CODE	HTS CODE	PACKAGE CONTAINS
TSW200 000050	851762	8517.62.00	Standard package
TSW200 000010	851762	8517.62.00	Standard package (without DIN rail bracket)

For more information on all available packaging options – please contact us directly.

# TSW200 SPATIAL MEASUREMENTS & WEIGHT

## MAIN MEASUREMENTS

W x H x D dimensions for TSW200:

Device housing\*: 132 x 44.2 x 95.1 mm

Box: 173 x 71 x 148 mm

\*Housing measurements are presented without antenna connectors and screws; for measurements of other device elements look to the sections below.

## TOP VIEW

The figure below depicts the measurements of TSW200 and its components as seen from the top:

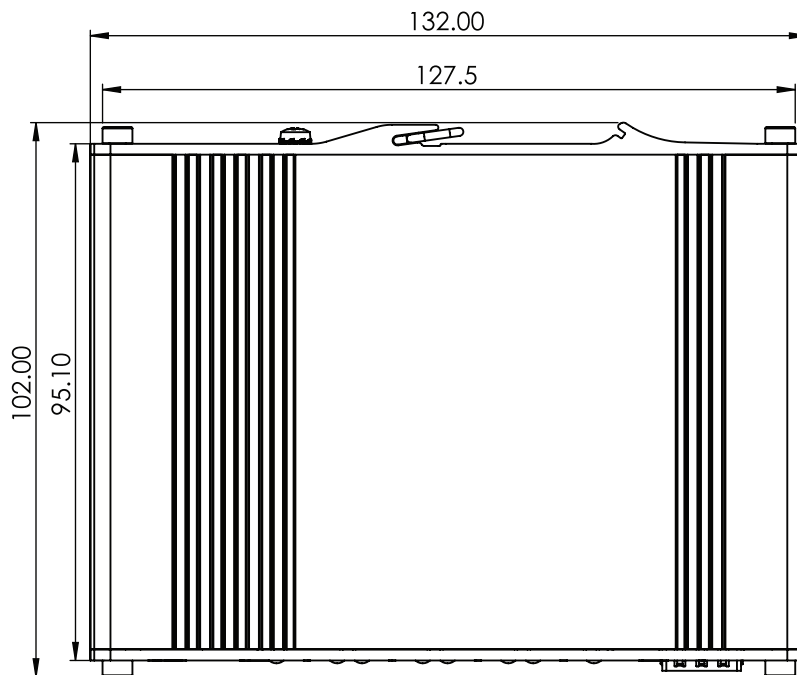

## RIGHT VIEW

The figure below depicts the measurements of TSW200 and its components as seen from the right side:

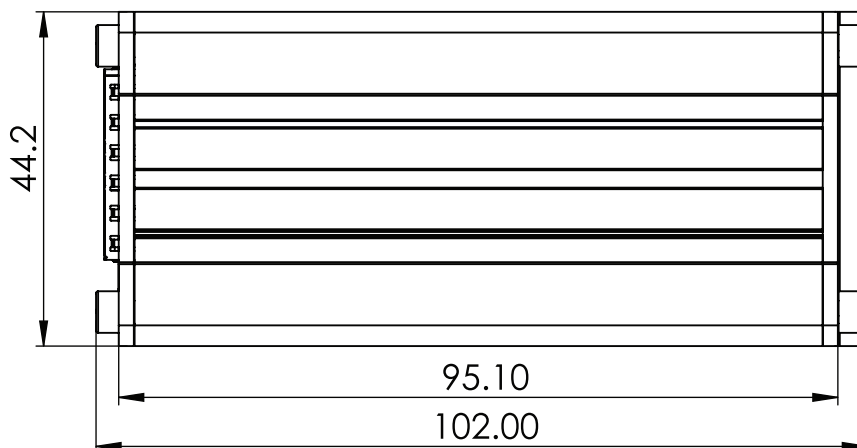

**FRONT VIEW**

The figure below depicts the measurements of TSW200 and its components as seen from the front panel side:

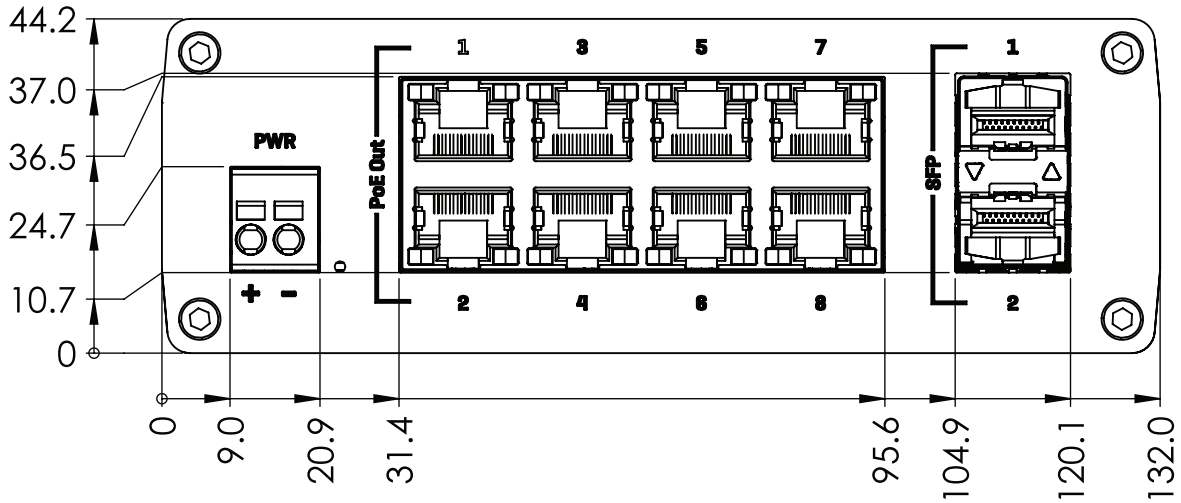

**REAR VIEW**

The figure below depicts the measurements of TSW200 and its components as seen from the back panel side:

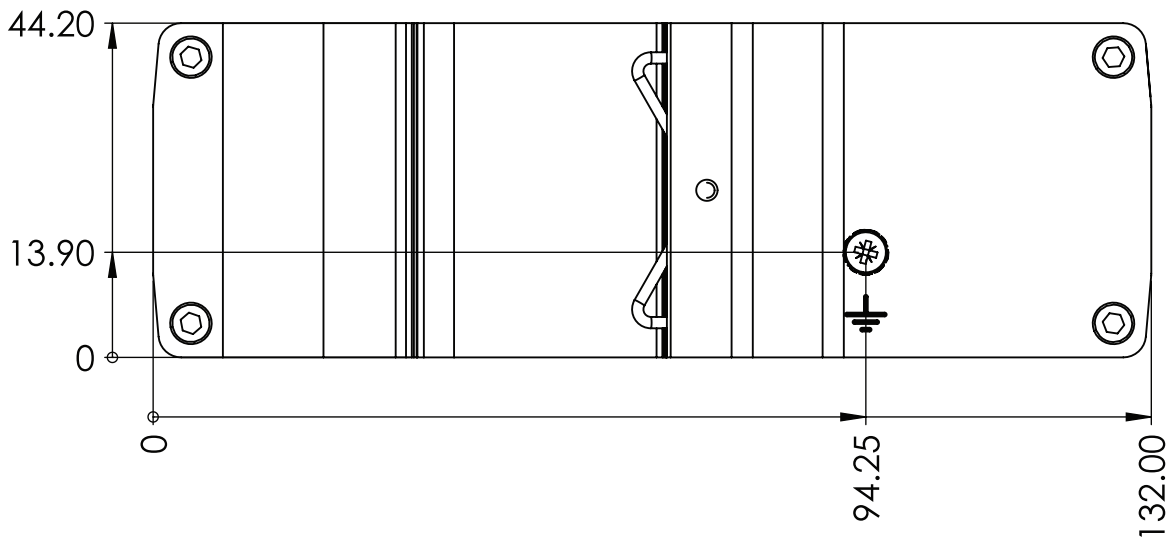

**MOUNTING SPACE REQUIREMENTS**

The figure below depicts an approximation of the device's dimensions when cables and antennas are attached:

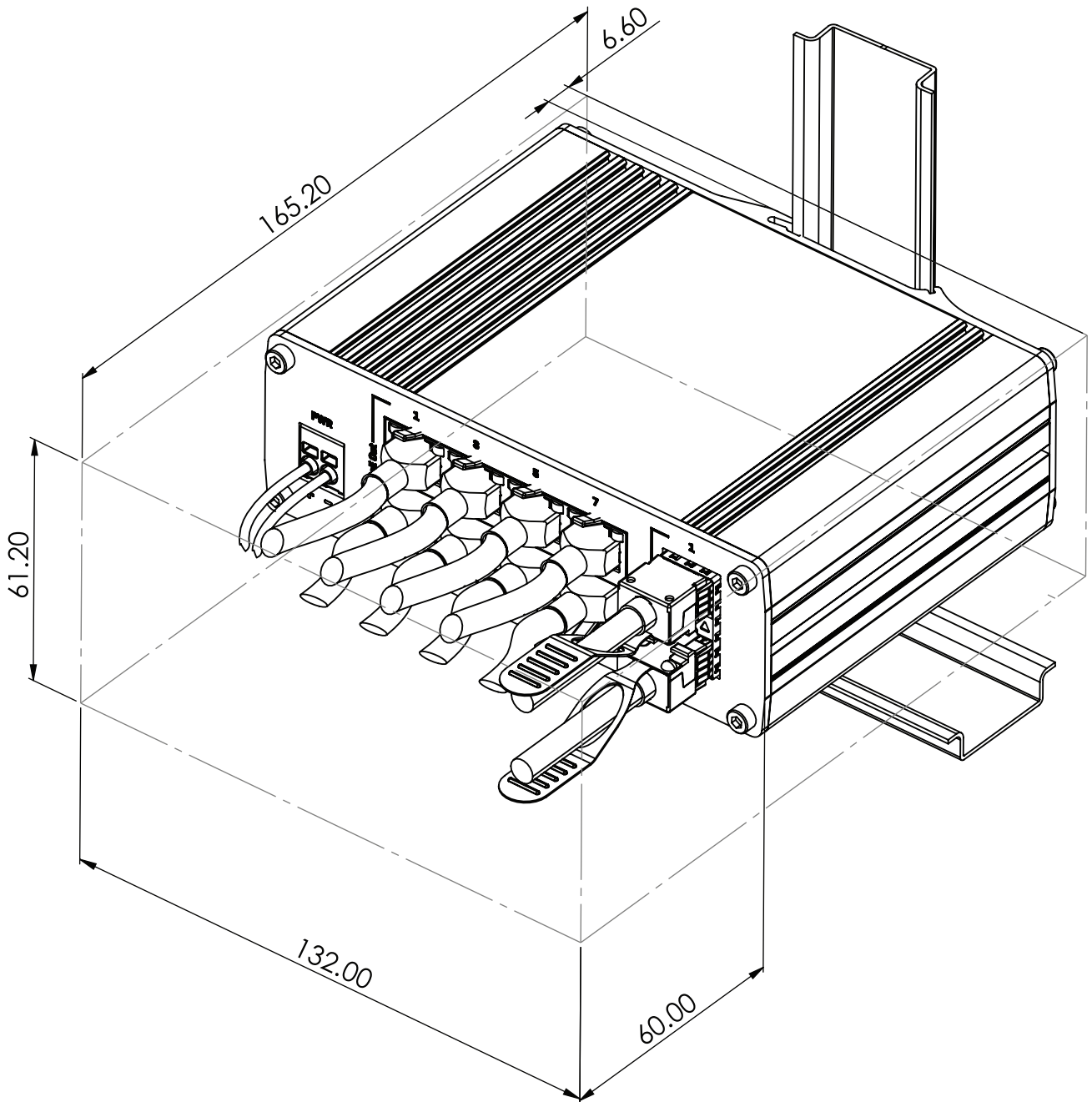

DIN RAIL

The scheme below depicts protrusion measurements of an attached DIN Rail:

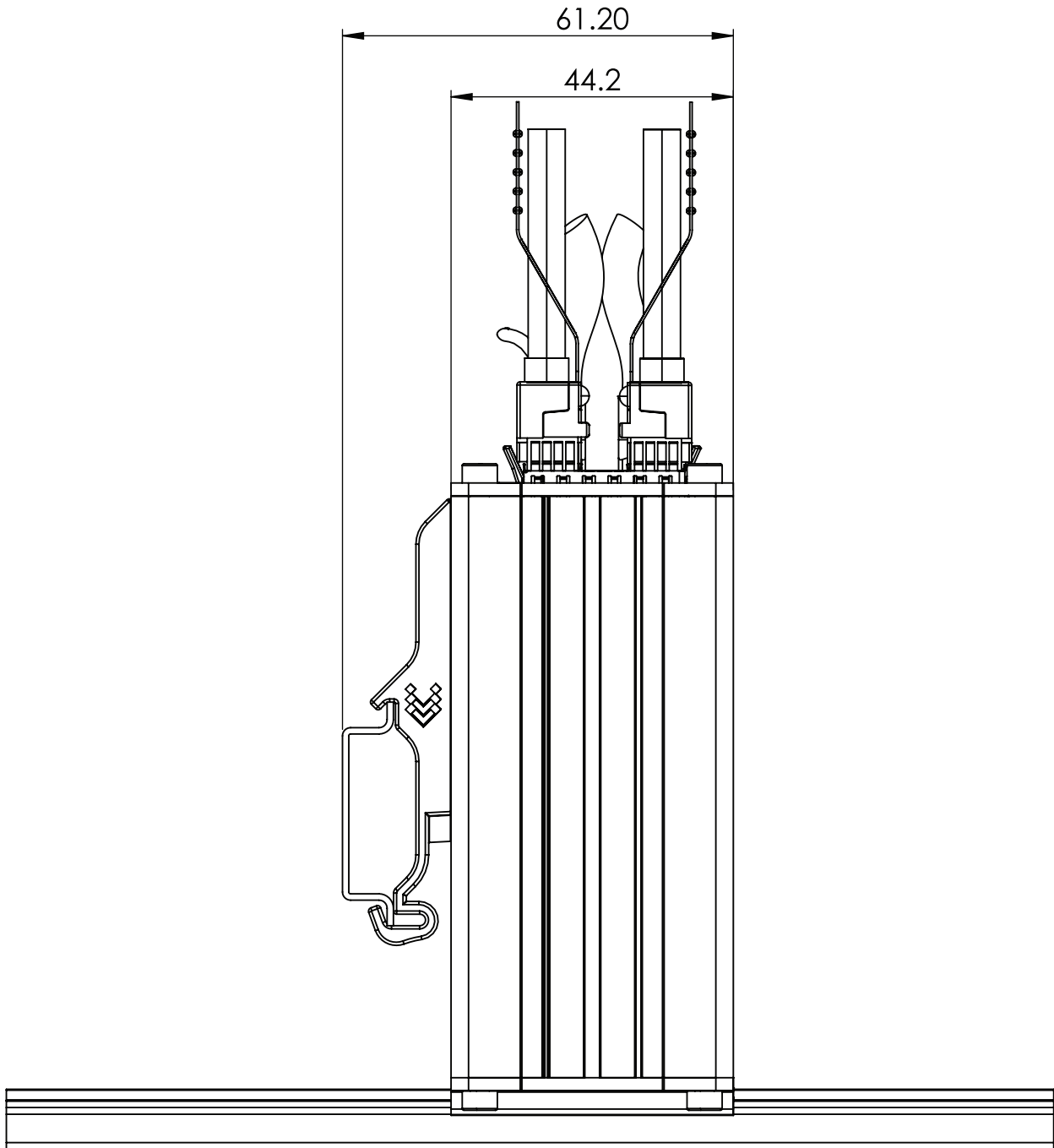

UK SALES : Millbeck - 01937 534914 Order online at [3grouterstore.co.uk](http://3grouterstore.co.uk)