



5G Industrial Router
RAPID-NR550

User Manual

This manual is applicable to the following products: NR550



Note: There may be differences between models of accessories and interfaces, actual products shall prevail.

Copyright Notice

All contents in the files are protected by copyright law, and all copyrights are reserved by Proroute Ltd

Without written permission, all commercial use of the files from Proroute Ltd are forbidden, such as copy, distribute, reproduce the files, etc., but non-commercial purpose, downloaded or printed by individual (all files shall be not revised, and the copyright and other proprietorship notice shall be reserved) are welcome.

Trademark Notice

Proroute®, RAPID®, H685®, Speedroute® are all registered trademarks of Proroute Ltd

Illegal use of the name of Proroute, trademarks and other marks of Proroute is forbidden, unless written permission is authorised in advance.

Contact Us

Website:

www.proroute.co.uk

Tel:

E-mail:

info@proroute.co.uk

Content

Chapter 1 Product Introduction.....	1
1.1 Product Overview	1
1.2 Diagram of Working Principle	2
Chapter 2 Installation	3
2.1 Overview.....	3
2.2 Packing List.....	3
2.3 Installation and Cable Connection	4
2.4 Power Supply	7
2.5 Indicators.....	7
2.6 Reset Button.....	8
Chapter 3 Configuration and Management	9
3.1 Configuration Connection	9
3.2 Access the Configuration on Web Page.....	9
3.3 Management and Configuration	11
3.3.1 Setting	11
Basic Setting.....	11
Dynamic DNS	17
Clone MAC Address	18
Advanced Router	18
VLANS	20
Networking	20
3.3.2 Wireless.....	23
Basic Setting.....	23
Wireless Security	25
3.3.3 Services.....	27
Services	27
3.3.4 VPN	31
PPTP	31
L2TP.....	32
OPEN VPN	33
IPSEC	38

GRE	40
3.3.5 Security.....	42
Firewall	42
3.3.6 Access Restrictions	44
WAN Access	44
URL Filter	47
Packet Filter.....	48
3.3.7 NAT.....	49
Port Forwarding.....	49
Port Range Forward.....	49
DMZ	50
3.3.8 QoS Setting	51
Basic.....	51
Classify	51
3.3.9 Applications	52
Serial Applications	52
3.3.10 Administration	54
Management	54
Keep Alive.....	56
Commands.....	57
Factory Defaults	57
Firmware Upgrade.....	58
Backup	58
3.3.11 Status	59
Router	59
WAN	61
LAN	63
Wireless	66
Bandwidth	67
Sys-Info.....	69

Appendix.....	72
----------------------	-----------

Chapter 1 Product Introduction

1.1 Product Overview

RAPID NR550 is a wireless communication router for the Internet of Things, which uses public 3G/4G/5G networks to provide users with wireless long-distance big data transmission functions.

The product adopts high-performance industrial-grade 32-bit communication processor and industrial-grade wireless module, with embedded real-time operating system as the software support platform, and provides 1 RS232 (or RS485) + 4 Ethernet LAN + 1 Ethernet WAN + 2 WIFI interfaces, which can connect serial devices, Ethernet devices and WIFI devices at the same time to realize data transparent transmission and routing functions.

This product has been widely used in the M2M industry in the Internet of Things industry chain, such as smart grid, smart transportation, smart home, finance, mobile POS terminals, supply chain automation, industrial automation, smart buildings, fire protection, public safety, environmental protection, meteorology, Digital medical treatment, remote sensing survey, military, space exploration, agriculture, forestry, water affairs, coal mine, petrochemical and other fields.



1.2 Block Diagram of Working Principle

Block Diagram

Functional Block Diagram

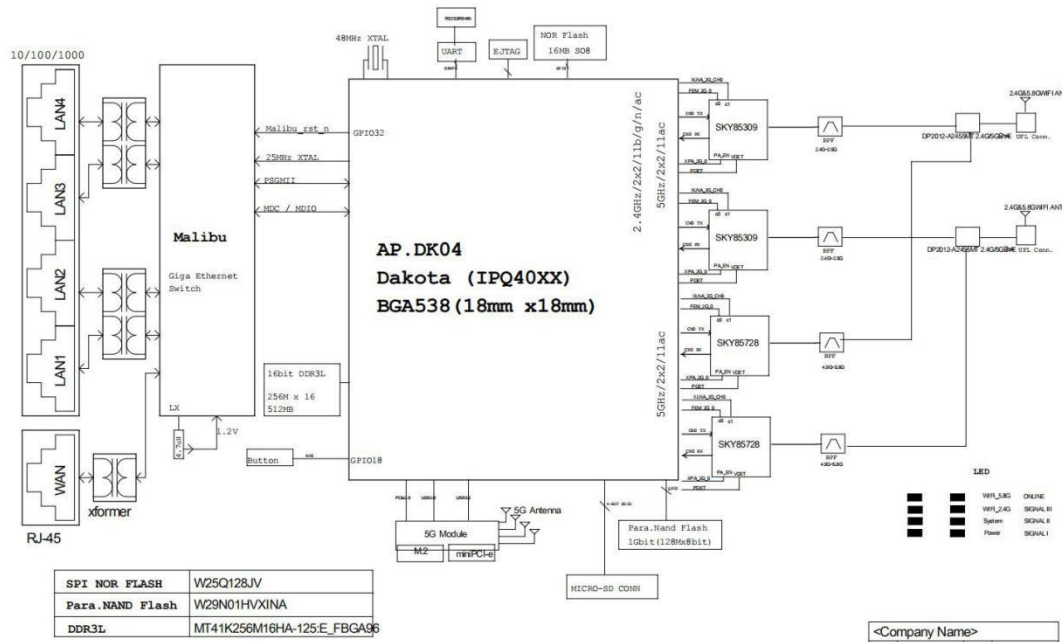

Chapter 2 Installation

2.1 Overview

5G routers must be installed correctly to achieve the designed functions. Usually the installation of the equipment must be carried out under the guidance of qualified engineers approved by the company.

2.2 Packing List

When you open the box, please keep the packing materials, so that you can use it when you need to transfer in the future.

The list is as follows:

- 1 x 5G router NR550
- 4 x 5G wireless cellular antennas (SMA male) - MAG MOUNT
- 4 x 5G wireless cellular antennas (SMA male) - Elbow Joint, Blade Antennas
- 2 x WIFI antenna (SMA female)
- 1 x UK Mains power supply (240VAC / 12VDC)
- 1 x Ethernet Cable
- 1 x Serial Interface Cable (RS232)

2.3 Installation and Cable Connection

Size(mm):

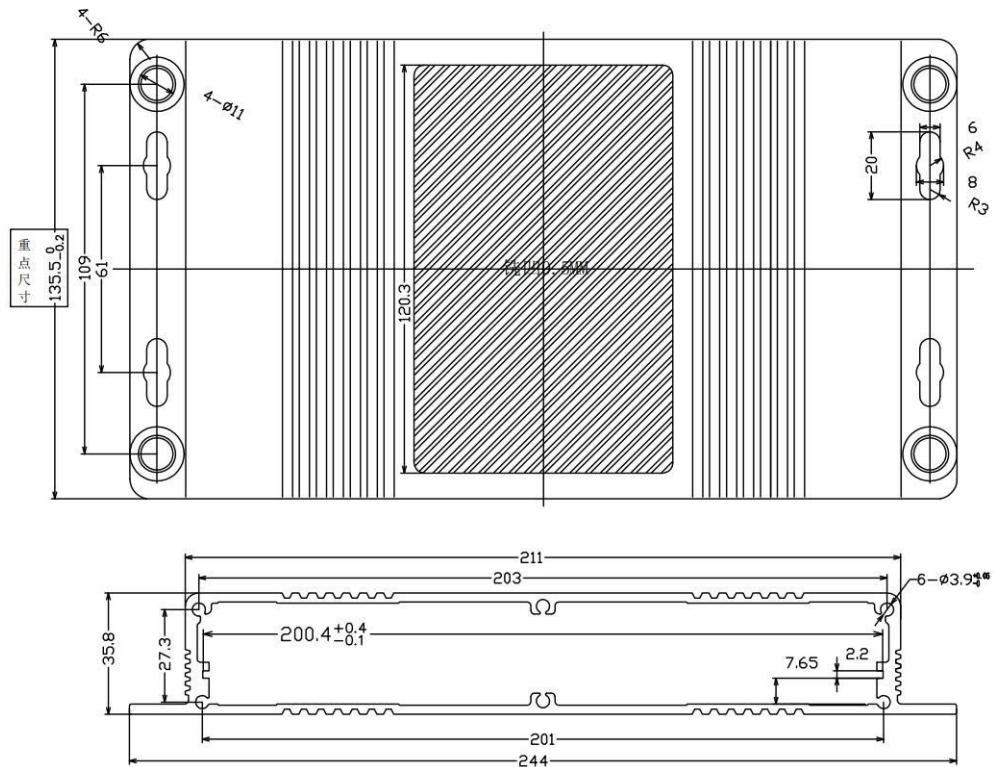

Antenna installation:

The 5G antenna interface is an SMA female socket. Screw the SMA male of the matching wireless cellular antenna to the antenna interface and make sure to tighten it. To increase the isolation of the 5G antenna, try to keep the antenna at an angle of 30 degrees to enhance signal quality.



The WIFI antenna interface is an SMA male socket. Screw the SMA female of the matching WIFI antenna to the antenna interface and make sure to tighten it. In addition, to increase the isolation of the Wi-Fi antenna, it is recommended that the two Wi-Fi are placed at a 90-degree angle.



SIM/UIM installation:

When installing or removing the SIM/UIM card, first use a pointed object to gently hold the eject button, and the SIM/UIM card sleeve will pop out. Put the SIM/UIM card into the card holder first, and make sure that the metal contact surface of the SIM/UIM card is facing outward, then insert the SIM/UIM card holder into the drawer.



Connect Console cable:

Plug the RJ45 end of the Console line into the Console interface (RS232) of the Router and plug the DB9 end into the RS232 serial interface of the user device. The signal connections of the Console are as follows:

Console (RS232)				
RJ45	Color	Pin Map	DB9F	Content
1	White/Orange	A	8	RS485-A (Optional)
2	Orange	B	6	RS485-B (Optional)
3	White/Green	RXD	2	RS232 RX
4	Blue	--	1	--
5	White/Blue	GND	5	GND
6	Green	TXD	3	RS232 TX
7	White/Brown	--	4	--
8	Brown	--	7	--



2.4 Power Supply

5G routers are usually used in complex external environments. To adapt to the complex application environment and improve the stability of the system, the router adopts advanced power supply technology. Users can use the standard 12VDC/1.5A power adapter to power the 5G router, or directly use the DC 9~36V power supply to power the router. When the user uses an external power supply to power the router, the stability of the power supply must be ensured (the ripple is less than 300mV, and the instantaneous voltage does not exceed 36V), and the power supply must be greater than 8W.

2.5 Indicators

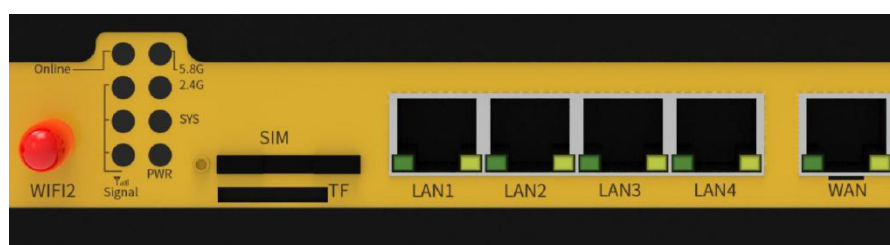

5G Router provide indicators as below: “Power”, “System”, “2.4G”, “5.8G”, “ONLINE”, “Signal”:

Indicator	Status	Content
Power	On	Device powered on
	Blank	System running normally
System	Off	System not running
	On	Device is online on internet
Online	Off	Device not online
	On	2.4G WIFI is on
2.4G	Off	2.4G WIFI is off
	On	5.8G WIFI is on
5.8G	Off	5.8G WIFI is off
	Off	WAN port not connected
WAN	On/blank	WAN port connected/communicating
	Off	LAN port not connected
LAN1~LAN4	On/blank	LAN port connected/communicating
	One light on	Weak(<-90dBm)
Signal Strength	Two lights on	Medium(-70dBm~-90dBm)
	Three lights on	Good(>-70dBm)

2.6 Reset Button

The 5G router has a reset button, marked as "RST"

The function of this button is to restore the parameter configuration of the 5G router to factory values

Methods as below: Power on device, let it running for 30 seconds, use a pen keep pressing the reset button for about 15 seconds, until all led turn off, the device will restart and reset to factory.

Chapter 3 Configuration and Management

This chapter describes how to configure and manage the Router.

3.1 Configuration Connection

Before configuration, you should connect the Router and your configuration PC with the supplied network cable. Plug the cable's one end into the Local Network port of the Router, and another end into your configure PC's Ethernet port. The connection diagram is as following:

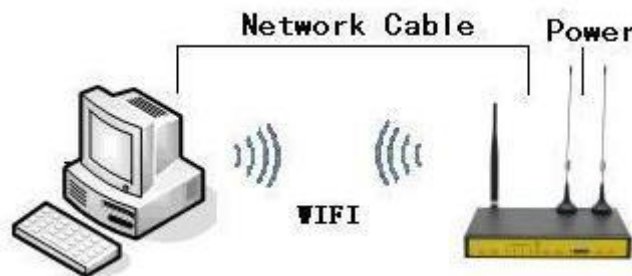

Please modify the IP address of PC as the same network segment address of the Router, for instance, 192.168.8.100. Modify the mask code of PC as 255.255.255.0 and set the default gateway of PC as the Router's IP address (192.168.8.1).

3.2 Access the Configuration Web Page

The chapter is to present main functions of each page. Users visit page tool via web browser after connecting users' PC to the Router. There are eleven main pages: Setting, Wireless, Service, VPN, Security, Access Restrictions, NAT, QoS Setting, Applications, Management and Status. Users enable to browse slave pages by click one main page.

Users can open IE or other explorers and enter the Router's default IP address of 192.168.1.1 on address bar, then press the button of Enter to visit page Web management tool of the Router. The user's login in the web page at the first name, there will display a page shows as blow to tip users to modify the default user name and password of the Router. Users must click "change password" to make it work if they modify user name and password.

Router Management

Your Router is currently not protected and uses an unsafe default username and password combination, please change it using the following dialog!

Router Password

Router Username	<input type="text" value="admin"/>
Router Password	<input type="password" value="••••"/>
Re-enter to confirm	<input type="password" value="••••"/>

Change Password

After access to the information main page

Menu Setup Wireless Services VPN Security NAT Access Restrictions QoS Setting Applications Administration Status	System Information <table><tr><td colspan="2">Router</td></tr><tr><td>Router Name</td><td>Router</td></tr><tr><td>Router Model</td><td>Router</td></tr><tr><td>LAN MAC</td><td>00:0C:43:8C:B6:D6</td></tr><tr><td>WAN MAC</td><td>00:0C:43:8C:B6:D7</td></tr><tr><td>Wireless MAC</td><td>00:0C:43:8C:B6:D8</td></tr><tr><td>WAN IP</td><td>192.168.9.223</td></tr><tr><td>LAN IP</td><td>192.168.1.1</td></tr></table> <table><tr><td colspan="2">Wireless</td></tr><tr><td>Radio</td><td>Radio is On</td></tr><tr><td>Mode</td><td>AP</td></tr><tr><td>Network</td><td>Mixed</td></tr><tr><td>SSID</td><td>ssid-7620a</td></tr><tr><td>Channel</td><td>6 (2437 MHz)</td></tr><tr><td>TX Power</td><td>71 mW</td></tr><tr><td>Rate</td><td>300 Mb/s</td></tr></table> <table><tr><td colspan="2">Wireless Packet Info</td></tr><tr><td>Received (RX)</td><td>0 OK, no error</td></tr><tr><td>Transmitted (TX)</td><td>0 OK, no error</td></tr></table>	Router		Router Name	Router	Router Model	Router	LAN MAC	00:0C:43:8C:B6:D6	WAN MAC	00:0C:43:8C:B6:D7	Wireless MAC	00:0C:43:8C:B6:D8	WAN IP	192.168.9.223	LAN IP	192.168.1.1	Wireless		Radio	Radio is On	Mode	AP	Network	Mixed	SSID	ssid-7620a	Channel	6 (2437 MHz)	TX Power	71 mW	Rate	300 Mb/s	Wireless Packet Info		Received (RX)	0 OK, no error	Transmitted (TX)	0 OK, no error	<table><tr><td colspan="2">Services</td></tr><tr><td>DHCP Server</td><td>Enabled</td></tr><tr><td>ff-radauth</td><td>Disabled</td></tr><tr><td>USB Support</td><td>Enabled</td></tr></table> <table><tr><td colspan="2">Memory</td></tr><tr><td>Total Available</td><td>122.3 MB / 128.0 MB</td></tr><tr><td>Free</td><td>92.3 MB / 122.3 MB</td></tr><tr><td>Used</td><td>30.0 MB / 122.3 MB</td></tr><tr><td>Buffers</td><td>3.3 MB / 30.0 MB</td></tr><tr><td>Cached</td><td>11.6 MB / 30.0 MB</td></tr><tr><td>Active</td><td>10.3 MB / 30.0 MB</td></tr><tr><td>Inactive</td><td>6.4 MB / 30.0 MB</td></tr></table>	Services		DHCP Server	Enabled	ff-radauth	Disabled	USB Support	Enabled	Memory		Total Available	122.3 MB / 128.0 MB	Free	92.3 MB / 122.3 MB	Used	30.0 MB / 122.3 MB	Buffers	3.3 MB / 30.0 MB	Cached	11.6 MB / 30.0 MB	Active	10.3 MB / 30.0 MB	Inactive	6.4 MB / 30.0 MB
Router																																																																
Router Name	Router																																																															
Router Model	Router																																																															
LAN MAC	00:0C:43:8C:B6:D6																																																															
WAN MAC	00:0C:43:8C:B6:D7																																																															
Wireless MAC	00:0C:43:8C:B6:D8																																																															
WAN IP	192.168.9.223																																																															
LAN IP	192.168.1.1																																																															
Wireless																																																																
Radio	Radio is On																																																															
Mode	AP																																																															
Network	Mixed																																																															
SSID	ssid-7620a																																																															
Channel	6 (2437 MHz)																																																															
TX Power	71 mW																																																															
Rate	300 Mb/s																																																															
Wireless Packet Info																																																																
Received (RX)	0 OK, no error																																																															
Transmitted (TX)	0 OK, no error																																																															
Services																																																																
DHCP Server	Enabled																																																															
ff-radauth	Disabled																																																															
USB Support	Enabled																																																															
Memory																																																																
Total Available	122.3 MB / 128.0 MB																																																															
Free	92.3 MB / 122.3 MB																																																															
Used	30.0 MB / 122.3 MB																																																															
Buffers	3.3 MB / 30.0 MB																																																															
Cached	11.6 MB / 30.0 MB																																																															
Active	10.3 MB / 30.0 MB																																																															
Inactive	6.4 MB / 30.0 MB																																																															

Users need to input user name and password if it is their first time to login.



Input correct username and password to visit relevant menu page. Default username is admin, password is admin. (available to modify user name and password on management page, then click submit)

3.3 Management and Configuration

3.3.1 Setting

The Setup screen is the first screen users will see when accessing the Router. Most users will be able to configure the Router and get it work properly using only the settings on this screen. Some Internet Service Providers (ISPs) will require users to enter specific information, such as Username, Password, IP Address, Default Gateway Address, or DNS IP Address. This information can be obtained from your ISP, if required.

Basic Setting

WAN Connection Type

Seven Ways: Disabled, Static IP, Automatic Configuration-DHCP, PPPOE, 3G/UNMTS/4G/LTE, DHCP-4G.

1. Disabled

Forbid the setting of WAN port connection type

2. Static IP

Connection Type	Static IP
WAN IP Address	0 . 0 . 0 . 0
Subnet Mask	0 . 0 . 0 . 0
Gateway	0 . 0 . 0 . 0
Static DNS 1	0 . 0 . 0 . 0
Static DNS 2	0 . 0 . 0 . 0
Static DNS 3	0 . 0 . 0 . 0

WAN IP Address: Users set IP address by their own or ISP assigns

Subnet Mask: Users set subnet mask by their own or ISP assigns

Gateway: Users set gateway by their own or ISP assigns

Static DNS1/DNS2/DNS3: Users set static DNS by their own or ISP assigns

3. Automatic Configuration-DHCP

Connection Type	Automatic Configuration - DHCP
-----------------	--------------------------------

IP address of WAN port gets automatic via DHCP

4. PPPOE

Connection Type	PPPoE
User Name	<input type="text"/>
Password	<input type="password"/>
	<input type="checkbox"/> Unmask

Username: login the Internet

Password: login the Internet

5. 3G/UMTS/4G/LTE

Connection Type	3G/UMTS/4G/LTE
User Name	<input type="text"/>
Password	<input type="password"/>
	<input type="checkbox"/> Unmask
Dial String	*99***1# (UMTS/3G/3.5G)
APN	<input type="text"/>
PIN	<input type="text"/>
	<input type="checkbox"/> Unmask

Username: Login users' ISP (Internet Service Provider)

Password: Login users' ISP

Dial String: Dial number of users' ISP

APN: Access point name of users' ISP

PIN: PIN code of users' SIM card

6. Connection Type

Connection type

Connection type: Auto, Force 3G, Force 2G, prefer 3G, Prefer 2G options. If using 4G module, there has 4G network option. Users select different mode depending on their need

7. DHCP-4G

Connection Type

IP address of WAN port gets automatic via DHCP-4G

8. Keep Online

Keep Online Detection

Detection Interval

Primary Detection Server IP

Backup Detection Server IP

This function is used to detect whether the Internet connection is active, if users set it and when the Router detect the connection is inactive, it will redial to users' ISP immediately to make the connection active. If the network is busy or the user is in private network, we recommend that Router mode will be better.

9. Detection Method

None: Do not set this function

Ping: Send ping packet to detect the connection, when choose this method, users should also configure "Detection Interval", "Primary Detection Server IP" and "Backup Detection Server IP" items.

Route: Detect connection with route method, when choose this method, users should also configure "Detection Interval", "Primary Detection Server IP" and "Backup Detection Server IP" items.

PPP: Detect connection with PPP method, when choose this method, users should also configure "Detection Interval" item.

Detection Interval: Time interval between two detections, unit is second

Primary Detection Server IP: The server used to response the Router's detection packet. This item is only valid for method "Ping" and "Route".

Backup Detection Server IP: The server used to response the Router’s detection packet. This item is valid for method "Ping" and "Route".

Note: When users choose the “Route” or “Ping” method, it’s quite important to make sure that the “Primary Detection Server IP” and “Backup Detection Server IP” are usable and stable, because they have to response the detection packet frequently.

Force reconnect Enable Disable
 Time 00:00

Force Reconnect: This option schedules the PPPOE or 3G reconnection by killing the PPPD daemon and restart it.

Time: Needed time to reconnect

10. STP

STP Enable Disable

STP (Spanning Tree Protocol) can be applied to loop network. Through certain algorithm achieves path redundancy, and loop network cuts to tree-based network without loop in the meantime, thus, to avoid the hyperplasia and infinite circulation of a message in the loop network

11. Optional Configuration

Router Name NR550
 Host Name
 Domain Name
 MTU Auto 1500

Router Name: Set Router name

Host Name: ISP provides

Domain Name: ISP provides

MTU: Auto (1500) and manual (1200-1492 in PPPOE/PPTP/L2TP mode, 576-16320 in other modes)

12. Router Internal Network Settings

Router IP

Local IP Address 192.168.8.1
 Subnet Mask 255.255.255.0
 Gateway 0.0.0.0
 Local DNS 0.0.0.0

Local IP Address: IP address of the Router

Subnet Mask: The subnet mask of the Router

Gateway: Set internal gateway of the Router. If default, internal gateway is the address of the Router

Local DNS: DNS server is auto assigned by network operator server. Users enable to use their own DNS server or other stable DNS servers, if not, keep it default

13. Network Address Server Settings (DHCP)

These settings for the Router's Dynamic Host Configuration Protocol (DHCP) server functionality configuration. The Router can serve as a network DHCP server. DHCP server automatically assigns an IP address for each computer in the network. If they choose to enable the Router's DHCP server option, users can set all the computers on the LAN to automatically obtain an IP address and DNS, and make sure no other DHCP server in the network.

DHCP Type	DHCP Server
DHCP Server	<input checked="" type="radio"/> Enable <input type="radio"/> Disable
Start IP Address	192.168.1.100
Maximum DHCP Users	50
Client Lease Time	1440 minutes
Static DNS 1	0.0.0.0
Static DNS 2	0.0.0.0
Static DNS 3	0.0.0.0
WINS	0.0.0.0
Use DNSMasq for DHCP	<input checked="" type="checkbox"/>
Use DNSMasq for DNS	<input checked="" type="checkbox"/>
DHCP-Authoritative	<input checked="" type="checkbox"/>

DHCP Type: DHCP Server and DHCP Forwarder

Enter DHCP Server if set DHCP Type to DHCP Forwarder as blow:

DHCP Type	DHCP Forwarder
DHCP Server	0.0.0.0

DHCP Server: Keep the default Enable to enable the Router's DHCP server option. If users have already had a DHCP server on their network or users do not want a DHCP server, then select Disable

Start IP Address: Enter a numerical value for the DHCP server to start with when issuing IP addresses. Do not start with 192.168.1.1 (the Router's own IP address)

Maximum DHCP Users: Enter the maximum number of PCs that users want the DHCP server to assign IP addresses to. The absolute maximum is 253 if 192.168.1.2 is users' starting IP address.

Client Lease Time: The Client Lease Time is the amount of time a network user will be allowed connection to the Router with their current dynamic IP address. Enter the amount of time, in minutes, that the user will be "leased" this dynamic IP address.

Static DNS (1-3): The Domain Name System (DNS) is how the Internet translates domain or website names into Internet addresses or URLs. Users' ISP will provide them with at least one DNS Server IP address. If users wish to utilize another, enter that IP address in one of these fields. Users can enter up to three DNS Server IP addresses here. The Router will utilize them for quicker access to functioning DNS servers.

WINS: The Windows Internet Naming Service (WINS) manages each PC's interaction with the Internet. If users use a WINS server, enter that server's IP address here. Otherwise, leave it blank.

DNSMasq: Users' domain name in the field of local search, increase the expansion of the host option, to adopt DNSMasq can assign IP addresses and DNS for the subnet, if select DNSMasq, DHCPD service is used for the subnet IP address and DNS.

14. Time Settings

Select time zone of your location. To use local time, leave the checkmark in the box next to Use local time.

NTP Client	<input checked="" type="checkbox"/> Enable <input type="checkbox"/> Disable
Time Zone	UTC+08:00 ▾
Summer Time (DST)	last Sun Mar - last Sun Oct ▾
Server IP/Name	<input type="text"/>

NTP Client: Get the system time from NTP server

Time Zone: Time zone options

Summer Time (DST): set it depends on users' location

Server IP/Name: IP address of NTP server, up to 32 characters. If blank, the system will find a server by default

15. Adjust Time

Time	2012-3-15 9:16:20	Get	Set
------	-------------------	-----	-----

To adjust time by the system and refresh to get the time of the web, user can set to modify the time of the system. They can change to adjust time by manual to achieve adjust time by the system if the system fails to get NTP server.

Dynamic DNS

If user's network has a permanently assigned IP address, users can register a domain name and have that name linked with their IP address by public Domain Name Servers (DNS). However, if their Internet account uses a dynamically assigned IP address, users will not know in advance what their IP address will be, and the address can change frequently. In this case, users can use a commercial dynamic DNS service, which allows them to register their domain to their IP address and will forward traffic directed at their domain to their frequently-changing IP address.

DDNS Service: Router currently support DynDNS, freedns, Zoneedit, NO-IP, 3322, easyDNS, TZO, DynSIP and Custom based on the user.

DDNS Service	<input type="text" value="3322.org"/>	<input type="button" value="v"/>
User Name	<input type="text"/>	
Password	<input type="text"/>	<input type="checkbox"/> Unmask
Host Name	<input type="text"/>	
Type	<input type="text" value="Dynamic"/>	<input type="button" value="v"/>
Wildcard	<input type="checkbox"/>	
Do not use external ip check	<input checked="" type="radio"/> Yes	<input type="radio"/> No

Username: Users register in DDNS server, up to 64 characteristic **Password:** password for the username that users register in DDNSserver, up to 32 characteristic

Host Name: Users register in DDNS server, no limited for input characteristic for now

Type: depends on the server

Wildcard: Support wildcard or not, the default is OFF. ON means

*.host.3322.org is equal to host.3322.org

Do not use external IP check: Enable or disable the function of 'do not use external ip check'

Force Update Interval	<input type="text" value="10"/>	(Default: 10 Days, Range: 1 - 60)
-----------------------	---------------------------------	-----------------------------------

Force Update Interval: Unit is day, try forcing the update dynamic DNS to the server by settled days

Status

DDNS Status

```
Fri Nov 25 13:58:32 2011: INADYN: Started 'INADYN Advanced version 1.96-ADV' - dynamic DNS updater.  
Fri Nov 25 13:58:32 2011: INADYN: IP read from cache file is '192.168.8.222'. No update required.  
Fri Nov 25 13:58:32 2011: I:INADYN: IP address for alias 'testsixin.3322.org' needs update to '192.168.8.38'  
Fri Nov 25 13:58:33 2011: I:INADYN: Alias 'testsixin.3322.org' to IP '192.168.8.38' updated successfully.
```

DDNS Status shows connection log information

Clone MAC Address

Some ISP need the users to register their MAC address. The users can clone the Router MAC address to their MAC address registered in ISP if they do not want to re-register their MAC address

Enable Disable

Clone LAN MAC

Clone WAN MAC

Clone Wireless MAC

Clone MAC address: Can clone three parts: Clone LAN MAC, Clone WAN MAC, Clone Wireless MAC.

Noted: That one MAC address is 48 characteristics, cannot be set to the multicast address, the first byte must be even. And MAC address value of network bridge br0 is determined by the smaller value of wireless MAC address and LAN port MAC address.

Advanced Router

Operating Mode: Gateway and Router

Operating Mode

Operating Mode

If the Router is hosting users' Internet connection, select Gateway mode. If another Router exists on their network, select Router mode.

Dynamic Routing

Dynamic Routing

Interface Disable ▾

Dynamic Routing enables the Router to automatically adjust to physical changes in the network's layout and exchange routing tables with other Routers. The Router determines the network packets' route based on the fewest number of hops between the source and destination.

To enable the Dynamic Routing feature for the WAN side, select WAN. To enable this feature for the LAN and wireless side, select LAN&WLAN. To enable the feature for both the WAN and LAN, select Both. To disable the Dynamic Routing feature for all data transmissions, keep the default setting, Disable.

Note: Dynamic Routing is not available in Gateway mode

Static Routing

Static Routing

Select set number 1 () ▾ Delete

Route Name

Metric

Destination LAN NET ...

Subnet Mask ...

Gateway ...

Interface LAN & WLAN ▾

Show Routing Table

Select Set Number: 1-50

Route Name: Defined routing name by users, up to 25 characters

Metric: 0-9999

Destination LAN NET: The Destination IP Address is the address of the network or host to which users want to assign a static route

Subnet Mask: The Subnet Mask determines which portion of an IP address is the network portion, and which portion is the host portion

Gateway: IP address of the gateway device that allows for contact between the Router and the network or host.

Interface: Indicate users whether the Destination IP Address is on the LAN & WLAN (internal wired and wireless networks), the WAN (Internet), or Loopback (a dummy network in which one PC acts like a network, necessary for certain software programs)

Show Routing Table:

Routing Table Entry List			
Destination LAN NET	Subnet Mask	Gateway	Interface
192.168.1.1	255.255.255.255	0.0.0.0	WAN
192.168.1.0	255.255.255.0	0.0.0.0	LAN & WLAN
192.168.1.0	255.255.255.0	0.0.0.0	WAN
169.254.0.0	255.255.0.0	0.0.0.0	WAN
0.0.0.0	0.0.0.0	192.168.1.1	LAN & WLAN

VLANs

VLAN

VLAN	Port					Assigned To Bridge
	W	1	2	3	4	
1	<input type="checkbox"/>	<input checked="" type="checkbox"/>	<input checked="" type="checkbox"/>	<input checked="" type="checkbox"/>	<input checked="" type="checkbox"/>	LAN ▾
2	<input checked="" type="checkbox"/>	<input type="checkbox"/>	<input type="checkbox"/>	<input type="checkbox"/>	<input type="checkbox"/>	None ▾
3	<input type="checkbox"/>	<input type="checkbox"/>	<input type="checkbox"/>	<input type="checkbox"/>	<input type="checkbox"/>	LAN ▾
4	<input type="checkbox"/>	<input type="checkbox"/>	<input type="checkbox"/>	<input type="checkbox"/>	<input type="checkbox"/>	LAN ▾
5	<input type="checkbox"/>	<input type="checkbox"/>	<input type="checkbox"/>	<input type="checkbox"/>	<input type="checkbox"/>	LAN ▾
6	<input type="checkbox"/>	<input type="checkbox"/>	<input type="checkbox"/>	<input type="checkbox"/>	<input type="checkbox"/>	None ▾
7	<input type="checkbox"/>	<input type="checkbox"/>	<input type="checkbox"/>	<input type="checkbox"/>	<input type="checkbox"/>	None ▾
8	<input type="checkbox"/>	<input type="checkbox"/>	<input type="checkbox"/>	<input type="checkbox"/>	<input type="checkbox"/>	None ▾
9	<input type="checkbox"/>	<input type="checkbox"/>	<input type="checkbox"/>	<input type="checkbox"/>	<input type="checkbox"/>	None ▾
10	<input type="checkbox"/>	<input type="checkbox"/>	<input type="checkbox"/>	<input type="checkbox"/>	<input type="checkbox"/>	None ▾
11	<input type="checkbox"/>	<input type="checkbox"/>	<input type="checkbox"/>	<input type="checkbox"/>	<input type="checkbox"/>	None ▾
12	<input type="checkbox"/>	<input type="checkbox"/>	<input type="checkbox"/>	<input type="checkbox"/>	<input type="checkbox"/>	None ▾
13	<input type="checkbox"/>	<input type="checkbox"/>	<input type="checkbox"/>	<input type="checkbox"/>	<input type="checkbox"/>	None ▾
14	<input type="checkbox"/>	<input type="checkbox"/>	<input type="checkbox"/>	<input type="checkbox"/>	<input type="checkbox"/>	None ▾
15	<input type="checkbox"/>	<input type="checkbox"/>	<input type="checkbox"/>	<input type="checkbox"/>	<input type="checkbox"/>	None ▾

VLANs function is to divide different VLAN ports by users' will. The system supports 15 VLAN port from VLAN1-VLAN15. However, there is only 5-time ports (1 WAN port and 4 LAN port) divided by users themselves, and LAN port and WAN port disable to divide into one VLAN port meanwhile.

Networking

Bridging

Create Bridge

Bridge 0 br0 STP Off Prio 32768 MTU 1500

Assign to Bridge

Current Bridging Table

Bridge Name	STP enabled	Interfaces
br0	no	vlan0 ra0

Bridging-Create Bridge: Creates a new empty network bridge for later use. STP means Spanning Tree Protocol and with PRIO users can set the bridge priority order. The lowest number has the highest priority.

Bridging - Assign to Bridge: Allows users to assign any valid interface to a network bridge. Consider setting the Wireless Interface options to Bridged if they want to assign any Wireless Interface here. Any system specific bridge setting can be overridden here in this field.

Current Bridging Table: Shows current bridging table

Create steps as below:

Click 'Add' to create a new bridge, configuration is as below:

Create Bridge

Bridge 0 br0 STP Off Prio 32768 MTU 1500

Bridge 1 br1 STP On Prio 32768 MTU 1500

Create bridge option: the first br0 means bridge name. STP means to on/off spanning tree protocol. Prio means priority level of STP, the smaller the number, the higher the level. MTU means maximum transfer unit, default is 1500, delete if it is not need. And then click 'Save' or 'Add'. Bridgeproperties is as below:

Create Bridge

Bridge 0 br0 STP Off Prio 32768 MTU 1500

Bridge 1 br1 STP On Prio 32768 MTU 1500

IP Address 0.0.0.0

Subnet Mask 0.0.0.0

Enter relevant bridge IP address and subnet mask, click 'Add' to create a

bridge.

Note: Only create a bridge can apply it.

Assign to Bridge

Assignment 0 Interface Prio

- none
- br0
- br1

Assign to Bridge option: to assign different ports to created bridge. For example: assign port (wireless port) is ra0 in br1 bridge as below:

Prio means priority level: work if multiple ports are within the same bridge. The smaller the number, the higher the level. Click 'Add' to take it effect.

Note: corresponding interface of WAN ports interface should not be binding, this bridge function is basically used for LAN port, and should not be binding with WAN port

If bind success, bridge binding list in the list of current bridging table is as below:

Current Bridging Table

Bridge Name	STP enabled	Interfaces
br0	no	vlan0
br1	yes	ra0

To make br1 bridge has the same function with DHCP assigned address, users need to set multiple DHCP function, see the introduction of multi-channel DHCPD:

Port Setup

Network Configuration eth2	<input type="radio"/> Unbridged	<input checked="" type="radio"/> Default
Network Configuration vlan0	<input type="radio"/> Unbridged	<input checked="" type="radio"/> Default
Network Configuration ra0	<input type="radio"/> Unbridged	<input checked="" type="radio"/> Default
Network Configuration apcli0	<input type="radio"/> Unbridged	<input checked="" type="radio"/> Default
Network Configuration wds0	<input type="radio"/> Unbridged	<input checked="" type="radio"/> Default
Network Configuration wds1	<input type="radio"/> Unbridged	<input checked="" type="radio"/> Default
Network Configuration wds2	<input type="radio"/> Unbridged	<input checked="" type="radio"/> Default
Network Configuration wds3	<input type="radio"/> Unbridged	<input checked="" type="radio"/> Default
Network Configuration br0	<input type="radio"/> Unbridged	<input checked="" type="radio"/> Default

Port Setup: Set the port property, the default is not set

Network Configuration ra0	<input checked="" type="radio"/> Unbridged <input type="radio"/> Default
MTU	<input type="text" value="1500"/>
Multicast forwarding	<input type="radio"/> Enable <input checked="" type="radio"/> Disable
Masquerade / NAT	<input checked="" type="radio"/> Enable <input type="radio"/> Disable
IP Address	<input type="text" value="0"/> . <input type="text" value="0"/> . <input type="text" value="0"/> . <input type="text" value="0"/>
Subnet Mask	<input type="text" value="0"/> . <input type="text" value="0"/> . <input type="text" value="0"/> . <input type="text" value="0"/>

Choose not bridge to set the port's own properties, detailed properties are as below:

MTU: Maximum transfer unit

Multicast Forwarding: Enable or disable multicast forwarding Masquerade/NAT:
enable or disable Masquerade/NAT

IP Address: Set ra0's IP address, and do not conflict with other ports or bridge Subnet

Mask: set the port's subnet mask

Multiple DHCP Server

DHCP 0	<input type="text" value="ra0"/>	<input type="text" value="On"/>	Start	<input type="text" value="100"/>	Max	<input type="text" value="50"/>	Leasetime	<input type="text" value="3600"/>
<input type="button" value="Delete"/>								
<input type="button" value="Add"/>								

Multiple DHCPD: Using multiple DHCP service. Click 'Add' in multiple DHCP server to appear relevant configuration. The first means the name of port or bridge (do not be configured as eth0), the second means whether to on DHCP. Start means start address, Max means maximum assigned DHCP clients, Lease time means the client lease time, the unit is second, click 'Save' or 'Apply' to put it into effect after setting.

Note: Only configure and click 'Save' can configure the next, cannot configure multiple DHCP at the same time.

3.3.2 Wireless

Basic Settings

Wireless Physical Interface wl0 [2.4 GHz]

Wireless Network Enable Disable

Physical Interface ra0 - SSID [dd-junjinlee] HWAddr [00:AA:BB:CC:DD:15]

Wireless Mode	<input type="text" value="AP"/>
Wireless Network Mode	<input type="text" value="N-Only"/>
802.11n Transmission Mode	<input type="text" value="Mixed"/>
Wireless Network Name (SSID)	<input type="text" value="dd-junjinlee"/>
Wireless Channel	<input type="text" value="11 - 2.462 GHz"/>
Channel Width	<input type="text" value="40 MHz"/>
Extension Channel	<input type="text" value="upper"/>
Wireless SSID Broadcast	<input checked="" type="radio"/> Enable <input type="radio"/> Disable
Network Configuration	<input type="radio"/> Unbridged <input checked="" type="radio"/> Bridged

Virtual Interfaces

Wireless Network: "Eanble", radio on.
 "Disable", radio off.

Wireless Mode: AP, Client, Adhoc, Repeater, Repeater Bridge four options.

Wireless Network Mode:

Mixed: Support 802.11b, 802.11g, 802.11n wireless devices.

BG-Mixed: Support 802.11b, 802.11g wireless devices.

B-only: Only supports the 802.11b standard wireless devices.

G-only: Only supports the 802.11g standard wireless devices.

NG-Mixed: Support 802.11g, 802.11n wireless devices.

N-only: Only supports the 802.11g standard wireless devices.

802.11n Transmission Mode : In the wireless network mode to "N-only" choose to transfer its transmission mode.

Greenfield: When you determine the surrounding environment, there is no other 802.11a/b/g devices use the same channel, use this mode to increase throughput. Other 802.11a/b/g devices use the same channel in the environment, the information you send may generate an error, re-issued.

Mixed This mode is contrary to the green mode but will reduce the throughput.

Wireless Network Name (SSID): The SSID is the network name shared among all devices in a wireless network. The SSID must be identical for all

devices in the wireless network. It is case-sensitive and must not exceed 32 alphanumeric characters, which may be any keyboard character. Make sure this setting is the same for all devices in your wireless network.

Wireless Channel: A total of 1-13 channels to choose more than one wireless device environment, please try to avoid using the same channel with other devices.

Channel Width: 20MHz and 40MHz.

Extension Channel: Channel for 40MHz, you can choose upper or lower.

Wireless SSID Broadcast:

Enable: SSID broadcasting.

Disable: Hidden SSID.

Network Configuration:

Bridged: Bridge to the Router, under normal circumstances, please select the bridge.

Unbridged: There is no bridge to the Router, IP addresses need to manually configure.

Network Configuration	<input checked="" type="radio"/> Unbridged <input type="radio"/> Bridged
Multicast forwarding	<input type="radio"/> Enable <input checked="" type="radio"/> Disable
Masquerade / NAT	<input checked="" type="radio"/> Enable <input type="radio"/> Disable
IP Address	<input type="text" value="192"/> . <input type="text" value="168"/> . <input type="text" value="1"/> . <input type="text" value="1"/>
Subnet Mask	<input type="text" value="255"/> . <input type="text" value="255"/> . <input type="text" value="0"/> . <input type="text" value="0"/>

Virtual Interfaces: Click Add to add a virtual interface. Add successfully, click on the remove, you can remove the virtual interface.

Virtual Interfaces

Virtual Interfaces ra1 SSID [dd-wrt_vap] HWAddr [00:AA:BB:CC:DD:16]

Wireless Network Name (SSID)	<input type="text" value="dd-wrt_vap"/>
Wireless SSID Broadcast	<input checked="" type="radio"/> Enable <input type="radio"/> Disable
AP Isolation	<input type="radio"/> Enable <input checked="" type="radio"/> Disable
Network Configuration	<input type="radio"/> Unbridged <input checked="" type="radio"/> Bridged

AP Isolation: This setting isolates wireless clients so access to and from other wireless clients are stopped.

Note : Save your changes, after changing the "Wireless Mode", "Wireless Network Mode", "wireless width", "broadband" option, please click on this button, and then configure the other options.

Wireless Security

Wireless security options used to configure the security of your wireless network. This route is a total of seven kinds of wireless security mode. Disabled by default, not safe mode is enabled. Such as changes in Safe Mode, click Apply to take effect immediately.

Wireless Security w10

Physical Interface ra0 SSID [dd-junjinlee] HWAddr [00:AA:BB:CC:DD:15]

Security Mode:

Wireless Security w10

Physical Interface ra0 SSID [four-faith] HWAddr [00:0C:43:30:52:79]

Security Mode:

Authentication Type: Open Shared Key

Default Transmit Key: 1 2 3 4

Encryption:

ASCII/HEX: ASCII HEX

Passphrase:

Key 1:

Key 2:

Key 3:

Key 4:

WEP: It's a basic encryption algorithm is less secure than WPA. Use of WEP is discouraged due to security weaknesses, and one of the WPA modes should be used whenever possible. Only use WEP if you have clients that can only support WEP (usually older, 802.11b-only clients).

Authentication Type: Open or shared key.

Default Transmit Key: Select the key form Key 1 - Key 4 key.

Encryption: There are two levels of WEP encryption, 64-bit (40-bit) and 128-bit. To utilize WEP, select the desired encryption bit, and enter a passphrase or up to four WEP key in hexadecimal format. If you are using 64-bit (40-bit), then each key must consist of exactly 10 hexadecimal characters or 5 ASCII characters. For 128-bit, each key must consist of exactly 26 hexadecimal characters. Valid hexadecimal characters are "0"-"9" and "A"-"F".

ASCII/HEX: ASCII, the keys is 5 bit ASCII characters/13bit ASCII characters.

HEX, the keys is 10bit/26 bit hex digits.

Passphrase: The letters and numbers used to generate a key.

Key1-Key4: Manually fill out or generated according to input the pass phrase.

Wireless Security w10

Physical Interface ra0 SSID [dd-junjinlee] HWAddr [00:AA:BB:CC:DD:15]

Security Mode: WPA Personal

WPA Algorithms: AES

WPA Shared Key: [masked] Unmask

Key Renewal Interval (in seconds): 3600 (Default: 3600, Range: 1 - 99999)

WPA Personal/WPA2 Personal/WPA2 Person Mixed: TKIP/AES/TKIP+AES, dynamic encryption keys. TKIP + AES, self-applicable TKIP or AES. WPA Person Mixed, allow WPA Personal and WPA2 Personal client mix.

WPA Shared Key: Between 8 and 63 ASCII character or hexadecimal digits. Key Renewal Interval (In seconds) : 1-99999.

Wireless Security w10

Physical Interface ra0 SSID [dd-junjinlee] HWAddr [00:AA:BB:CC:DD:15]

Security Mode: WPA Enterprise

WPA Algorithms: AES

Radius Auth Server Address: 192, 168, 1, 110

Radius Auth Server Port: 1812 (Default: 1812)

Radius Auth Shared Secret: [masked] Unmask

Key Renewal Interval (in seconds): 3600

WPA Enterprise/WPA2, Enterprise/WPA2, Enterprise Mixed: WPA Enterprise uses an external RADIUS server to perform user authentication.

WPA Algorithms: AES/TKIP/TPIP+AES.

Radius Auth Sever Address: The IP address of the RADIUS server.

Radius Auth Server Port: The RADIUS Port (default is 1812).

Radius Auth Shared Secret: The shared secret from the RADIUS server.

Key Renewal Interval (in seconds): 1-99999.

3.3.3 Services

Services

DHCP Server

DHCPd assigns IP addresses to users' local devices. While the main configuration is on the setup page users can program some nifty special functions here.

DHCP Server

Use JFFS2 for client lease DB *(Not mounted)*

Use NVRAM for client lease DB

Used Domain

LAN Domain

Additional DHCPd Options

Static Leases

MAC Address	Host Name	IP Address	Client Lease Time
<input type="text"/>	<input type="text"/>	<input type="text"/>	<input type="text" value="minutes"/>

Use NVRAM for Client Lease DB: Users can store data to the system NVRAM area is enabled.

Used domain: Users can select here which domain the DHCP clients should get as their local domain. This can be the WAN domain set on the Setup screen or the LAN domain which can be set here.

LAN Domain: Users can define here their local LAN domain which is used as local domain for DNSmasq and DHCP service if chose above.

Static Leases: If users want to assign certain hosts a specific address, then they can define them here. This is also the way to add hosts with a fixed address to the Router's local DNS service (DNSmasq).

Additional DHCPd Options: Some extra options users can set by entering them

DNSMasq

DNSmasq is a local DNS server. It will resolve all host names known to the Router from dhcp (dynamic and static) as well as forwarding and caching DNS entries from remote DNS servers. Local DNS enables DHCP clients on the LAN to resolve static and dynamic DHCP hostnames.

DNSMasq

DNSMasq Enable Disable

Local DNS Enable Disable

No DNS Rebind Enable Disable

Additional DNSMasq Options

Local DNS: Enables DHCP clients on the LAN to resolve static and dynamic DHCP hostnames.

No DNS Rebind: When enabled, it can prevent an external attacker to access the Router's internal Web interface. It is a security measure

Additional DNSMasq Options: Some extra options users can set by entering them in Additional DNS Options.

For example:

Static Allocation: Dhcp-host=AB:CD: EF:11:22:33,192.168.0.10,myhost,myhost.domain,12h

Max Lease Number: Dhcp-lease-max=2

DHCP Server IP Range: Dhcp-range=192.168.0.110,192.168.0.111,12h

SNMP

SNMP

SNMP Enable Disable

Location

Contact

Name

RO Community

RW Community

Location: Equipment location

Contact: Contact this equipment management

Name: Device name

RO Community: SNMP RO community name, the default is public, Only to read.

RW Community: SNMP RW community name, the default is private, Read-write permissions

SSHD

Enabling SSHd allows users to access the Linux OS of their Router with an SSH client

Secure Shell

SSHD	<input checked="" type="radio"/> Enable	<input type="radio"/> Disable
SSH TCP Forwarding	<input type="radio"/> Enable	<input checked="" type="radio"/> Disable
Password Login	<input checked="" type="radio"/> Enable	<input type="radio"/> Disable
Port	<input type="text" value="22"/>	(Default: 22)
Authorized Keys	<input type="text"/>	

SSH TCP Forwarding: Enable or disable to support the TCP forwarding

Password Login: Allows login with the Router password (username is admin)

Port: Port number for SSHd (default is 22)

Authorized Keys: Here users paste their public keys to enable key-based login (more secure than a simple password)

System log

Enable Syslog to capture system messages. By default they will be collected in the local file /var/log/messages. To send them to another system, enter the IP address of a remote syslog server.

System Log

Syslogd	<input checked="" type="radio"/> Enable	<input type="radio"/> Disable
Syslog Out Mode	<input checked="" type="radio"/> Net	<input type="radio"/> Console
Remote Server	<input type="text"/>	

Syslog Out Mode: Two log mode

Net: The log information output to a syslog server

Console: The log information output to console port

Remote Server: If choose net mode, users should input a syslog server's IP Address and run a syslog server program on it.

Telnet

Telnet

Telnet	<input checked="" type="radio"/> Enable	<input type="radio"/> Disable
--------	---	-------------------------------

Telnet: Enable a telnet server to connect to the Router with telnet. The username is admin and the password is the Router's password.

Note: If users use the Router in an untrusted environment (for example as a public hotspot), it is strongly recommended to use SSHd and deactivate telnet.

WAN Traffic Counter

WAN Traffic Counter

ttraff Daemon	<input checked="" type="radio"/> Enable	<input type="radio"/> Disable
---------------	---	-------------------------------

Ttraff Daemon: Enable or disable wan traffic counter function

3.3.4 VPN

1. PPTP

PPTP Server

PPTP Server

PPTP Server Enable Disable

Broadcast support Enable Disable

Force MPPE Encryption Enable Disable

DNS1

DNS2

WINS1

WINS2

Server IP

Client IP(s)

CHAP-Secrets

Broadcast Support: Enable or disable broadcast support of PPTP server

Force MPPE Encryption: Enable or disable force MPPE encryption of PPTP data

DNS1/DNS2/WINS1/WINS2: Set DNS1/DNS2/WINS1/WINS2

Server IP: Input IP address of the Router as PPTP server, differ from LAN address

Client IP(s): IP address assigns to the client, the format is xxx.xxx.xxx.xxx-xxx

CHAP Secrets: Username and password of the client using PPTP service

Note: Client IP must be different with IP assigned by Router DHCP. The format of CHAP Secrets is user * password *.

PPTP Client

PPTP Client

PPTP Client Options Enable Disable

Server IP or DNS Name

Remote Subnet ...

Remote Subnet Mask ...

MPPE Encryption

MTU (Default: 1450)

MRU (Default: 1450)

NAT Enable Disable

User Name

Password Unmask

Server IP or DNS Name: PPTP server's IP Address or DNS Name

Remote Subnet: The network of the remote PPTP server

Remote Subnet Mask: Subnet mask of remote PPTP server

MPPE Encryption: Enable or disable Microsoft Point-to-Point Encryption.

MTU: Maximum Transmission Unit

MRU: Maximum Receive Unit

NAT: Network Address Translation

Username: User name to login PPTP Server.

Password: Password to log into PPTP Server.

2. L2TP

L2TP Server

L2TP Server

L2TP Server Options Enable Disable

Force MPPE Encryption Enable Disable

Server IP

Client IP(s)

CHAP-Secrets

Force MPPE Encryption: Enable or disable force MPPE encryption of L2TP data

Server IP: Input IP address of the Router as PPTP server, differ from LAN address

Client IP(s): IP address assigns to the client, the format is xxx.xxx.xxx.xxx-xxx.xxx.xxx.xxx

CHAP Secrets: Username and password of the client using L2TP service

Note: Client IP must be different with IP assigned by Router DHCP.

The format of CHAP Secrets is user * password *.

L2TP Client

L2TP Client

L2TP Client Options	<input checked="" type="radio"/> Enable <input type="radio"/> Disable
User Name	<input type="text" value="DOMAIN\\Username"/>
Password	<input type="password"/> <input type="checkbox"/> Unmask
Gateway (L2TP Server)	<input type="text"/>
Remote Subnet	<input type="text" value="0"/> . <input type="text" value="0"/> . <input type="text" value="0"/> . <input type="text" value="0"/>
Remote Subnet Mask	<input type="text" value="0"/> . <input type="text" value="0"/> . <input type="text" value="0"/> . <input type="text" value="0"/>
MPPE Encryption	<input type="text" value="mppe required"/>
MTU	<input type="text" value="1450"/> (Default: 1450)
MRU	<input type="text" value="1450"/> (Default: 1450)
NAT	<input checked="" type="radio"/> Enable <input type="radio"/> Disable
Require CHAP	<input checked="" type="radio"/> Yes <input type="radio"/> No
Refuse PAP	<input checked="" type="radio"/> Yes <input type="radio"/> No
Require Authentication	<input checked="" type="radio"/> Yes <input type="radio"/> No

Gateway (L2TP Server): L2TP server's IP Address or DNS Name

Remote Subnet: The network of remote PPTP server

Remote Subnet Mask: Subnet mask of remote PPTP server

MPPE Encryption: Enable or disable Microsoft Point-to-Point Encryption

MTU: Maximum transmission unit

MRU: Maximum receive unit

NAT: Network address translation

Username: Username to login L2TP Server

Password: Password to login L2TP Server

Require CHAP: Enable or disable support chap authentication protocol

Refuse PAP: Enable or disable refuse to support the pap authentication

Require Authentication: Enable or disable support authentication protocol

3. OPENVPN

OPENVPN Server

Start Type WAN Up System

Start Type: WAN UP----start after on-line, System----- start when boot up

Config via GUI Config File

Server mode Router (TUN) Bridge (TAP)

Config via: GUI----Page configuration, Config File-----config File configuration

Server Mode: Router (TUN)-route mode, Bridge (TAP)-----bridge mode

Router (TUN):

Network	<input type="text" value="0.0.0.0"/>
Netmask	<input type="text" value="0.0.0.0"/>

Network: Network address allowed by OPENVPN server

Netmask: Netmask allowed by OPENVPN server

Bridge (TAP):

DHCP-Proxy mode	<input type="radio"/> Enable <input checked="" type="radio"/> Disable
Pool start IP	<input type="text" value="0.0.0.0"/>
Pool end IP	<input type="text" value="0.0.0.0"/>
Gateway	<input type="text" value="0.0.0.0"/>
Netmask	<input type="text" value="0.0.0.0"/>

DHCP-Proxy mode: Enable or disable DHCP-Proxy mode

Pool start IP: Pool start IP of the client allowed by OPENVPN server

Pool end IP: Pool end IP of the client allowed by OPENVPN server

Gateway: The gateway of the client allowed by OPENVPN server

Port	<input type="text" value="1194"/>	(Default: 1194)
Tunnel Protocol	<input type="text" value="UDP"/>	
Encryption Cipher	<input type="text" value="Blowfish CBC"/>	
Hash Algorithm	<input type="text" value="SHA1"/>	

Netmask: Netmask of the client allowed by OPENVPN server

Port: Listen port of OPENVPN server

Tunnel Protocol: UCP or TCP of OPENVPN tunnel protocol

Encryption Cipher: Blowfish CBC, AES-128 CBC, AES-192 CBC, AES-256 CBC, AES-512 CBC

Hash Algorithm: Hash algorithm provides a method of quick access to data, including SHA1, SHA256, SHA512, MD5

Advanced Options

Advanced Options	<input checked="" type="radio"/> Enable	<input type="radio"/> Disable
Use LZO Compression	<input type="radio"/> Enable	<input checked="" type="radio"/> Disable
Redirect default Gateway	<input type="radio"/> Enable	<input checked="" type="radio"/> Disable
Allow Client to Client	<input checked="" type="radio"/> Enable	<input type="radio"/> Disable
Allow duplicate cn	<input type="radio"/> Enable	<input checked="" type="radio"/> Disable
TUN MTU Setting	<input type="text" value="1500"/>	(Default: 1500)
MSS-Fix/Fragment across the tunnel	<input type="text"/>	(Default: Disable)
TLS Cipher	<input type="text" value="Disable"/>	
Client connect script	<input type="text"/>	

Use LZO Compression: Enable or disable use LZO compression for data transfer

Redirect Default Gateway: Enable or disable redirect default gateway

Allow Client to Client: Enable or disable allow client to client

Allow Duplicate cn: Enable or disable allow duplicate cn

TUN MTU Setting: Set the value of TUN MTU

TCP MSS: MSS of TCP data

TLS Cipher: TLS (Transport Layer Security) encryption standard supports AES-128 SHA and AES-256 SHA

Client Connect Script: define some client script by user self

CA Cert

CA Cert: CA certificate

Public Server Cert

Public Server Cert: Server certificate

Private Server Key

DH PEM

Private Server Key: The key selected by the server

DH PEM: PEM of the server

Additional Config

CCD-Dir DEFAULT file

TLS Auth Key

Certificate Revoke List

Additional Config: Additional configurations of the server

CCD-Dir DEFAULT file: Other file approaches

TLS Auth Key: Authority key of Transport Layer Security

Certificate Revoke List: Configure some revoke certificates

OPENVPN Client

Server IP/Name

Port

(Default: 1194)

Tunnel Device

Tunnel Protocol

Encryption Cipher

Hash Algorithm

nsCertType verification

Server IP/Name: IP address or domain name of OPENVPN server

Port: Listen port of OPENVPN client

Tunnel Device: TUN----Router mode, TAP-----Bridge mode

Tunnel Protocol: UDP and TCP protocol

Encryption Cipher: Blowfish CBC, AES-128 CBC, AES-192 CBC, AES-256 CBC, AES-512 CBC

Hash Algorithm: Hash algorithm provides a method of quick access to data, including SHA1, SHA256, SHA512, MD5

NsCertType Verification: Support ns certificate type

Advanced Options	<input checked="" type="radio"/> Enable	<input type="radio"/> Disable
Use LZO Compression	<input type="radio"/> Enable	<input checked="" type="radio"/> Disable
NAT	<input type="radio"/> Enable	<input checked="" type="radio"/> Disable
Bridge TAP to br0	<input type="radio"/> Enable	<input checked="" type="radio"/> Disable
Local IP Address	<input type="text"/>	
TUN MTU Setting	<input type="text" value="1500"/>	(Default: 1500)
MSS-Fix/Fragment across the tunnel	<input type="text"/>	(Default: Disable)
TLS Cipher	<input type="text" value="Disable"/>	
TLS Auth Key	<input type="text"/>	
Additional Config	<input type="text"/>	
Policy based Routing	<input type="text"/>	

Use LZO Compression: Enable or disable use LZO compression for data transfer

NAT: Enable or disable NAT through function

Bridge TAP to br0: Enable or disable bridge TAP to br0

Local IP Address: Set IP address of local OPENVPN client

TUN MTU Setting: Set MTU value of the tunnel

TCP MSS: Mss of TCP data

TLS Cipher: TLS (Transport Layer Security) encryption standard supports AES-128 SHA and AES-256 SHA

TLS Auth Key: Authority key of Transport Layer Security

Additional Config: Additional configurations of OPENVPN server

Policy Based Routing: Input some defined routing policy

CA Cert	<input type="text"/>
Public Client Cert	<input type="text"/>
Private Client Key	<input type="text"/>

CA Cert: CA certificate

Public Client Cert: Client certificate

Private Client Key: Client key

4. IPSEC

Connect Status and Control

Show IPSEC connection and status of current Router on IPSEC page.

Connection status and control				
Name	Type	Common Name	status	Action
<input type="button" value="Add"/>				

Name: The name of IPSEC connection

Type: The type and function of current IPSEC connection

Common Name: Local subnet, local address, opposite end address and opposite end subnet of current connection

Status: Connection status: closed, negotiating, establish

Closed: This connection does not launch a connection request to opposite end

Negotiating: This connection launch a request to opposite end, is under negotiating, the connection has not been established yet

Establish: The connection has been established, enabled to use this tunnel

Action: The action of this connection, current is to delete, edit, reconnect and enable

Delete: To delete the connection, also will delete IPSEC if IPSEC has set up

Edit: To edit the configure information of this connection, reload this connection to make the configuration effect after edit

Reconnect: This action will remove current tunnel, and re-launch tunnel establish request

Enable: When the connection is enabled, it will launch tunnel establish request when the system reboot or reconnect, otherwise the connection will not do it

Add: To add a new IPSEC connection

Add IPSEC connection or edit IPSEC connection

Type: To choose IPSEC mode and relevant functions in this part, supports tunnel mode client, tunnel mode server and transfer mode currently

Type	
Type	<input type="text" value="Net-to-Net Virtual Private Network"/>
IPSEC role	<input checked="" type="radio"/> Client <input type="radio"/> Server

Connection: This part contains basic address information of the tunnel

Connection

Name	<input type="text"/>	Enabled	<input checked="" type="checkbox"/>
Local WAN Interface	vlan1 <input type="button" value="v"/>	Remote Host address	<input type="text"/>
Local Subnet	<input type="text"/>	Remote subnet	<input type="text"/>
Local Id	<input type="text"/>	Remote ID	<input type="text"/>

Name: To indicate this connection name, must be unique

Enabled: If enable, the connection will send tunnel connection request when it is reboot or re-connection, otherwise it is no need if disable

Local WAN Interface: Local addresss of the tunnel

Remote Host Address: IP/domain name of end opposite; this option cannot fill in if using tunnel mode server

Local Subnet: IPSec local protects subnet and subnet mask, i.e. 192.168.1.0/24; this option cannot fill in if using transfer mode

Remote Subnet: IPSec opposite end protects subnet and subnet mask, i.e.192.168.7.0/24; this option cannot fill in if using transfer mode

Local ID: Tunnel local end identification, IP and domain name are available

Remote ID: Tunnel opposite end identification, IP and domain name are available

Detection: This part contains configure information of connection detection

Detection

Enable DPD Detection	<input checked="" type="checkbox"/>				
Time Interval	<input type="text" value="60"/> (S)	Timeout	<input type="text" value="60"/> (S)	Action	<input type="button" value="hold"/> <input type="button" value="v"/>
Enable Connection Detection	<input checked="" type="checkbox"/>				

Enable DPD Detection: Enable or disable this function, tick means enable

Time Interval: Set time interval of connect detection (DPD)

Timeout: Set the timeout of connect detection

Action: Set the action of connect detection

Advanced Settings: This part contains relevant setting of IKE, ESP, negotiation mode, etc.

Advanced Settings

Enable advanced settings

IKE Encryption: 3DES | IKE Integrity: MD5 | IKE Grouptype: MODP-8192

IKE Lifetime: 0 hours

ESP Encryption: 3DES | ESP Integrity: MD5

ESP Keylife: 0 hours

IKE+ESP: Use only proposed settings.

IKE aggressive mode allowed. Avoid if possible (preshared key is transmitted in clear text)!

Perfect Forward Secrecy (PFS)

Negotiate payload compression

Enable Advanced Settings: Enable to configure 1st and 2nd phase information, otherwise it will automatic negotiation according to opposite end

IKE Encryption: IKE phased encryption mode

IKE Integrity: IKE phased integrity solution

IKE Grouptype: DH exchange algorithm

IKE Lifetime: Set IKE lifetime, current unit is hour, the default is 0

ESP Encryption: ESP encryption type

ESP Integrity: ESP integrity solution

ESP Keylife: Set ESP keylife, current unit is hour, the default is 0

IKE Aggressive Mode Allowed: Negotiation mode adopt aggressive mode if tick; it is main mode if non-tick

Negotiate Payload Compression: Tick to enable PFS, non-tick to disable PFS

Authentication: choose use share encryption option or certificate authentication option. Current is only to choose use share encryption option.

Authentication

Use a Pre-Shared Key:

Generate and use the X.509 certificate

5. GRE

GRE (Generic Routing Encapsulation, Generic Routing Encapsulation) protocol is a network layer protocol (such as IP and IPX) data packets are encapsulated, so these encapsulated data packets to another network layer protocol (IP)transmission. GRE Tunnel (tunnel) technology, Layer Two Tunneling Protocol VPN (Virtual Private Network).

GRE Tunnel

GRE Tunnel

Enable Disable

GRE Tunnel: Enable or disable GRE function

Number	1 (fff) <input type="button" value="Delete"/>
Status	Enable <input type="button" value="v"/>
Name	fff
Through	PPP <input type="button" value="v"/>
Peer Wan IP Addr	120.42.46.98
Peer Subnet	192.168.5.0/24 (eg:192.168.1.0/24)
Peer Tunnel IP	200.200.200.1
Local Tunnel IP	200.200.200.5
Local Netmask	255.255.255.0

Number: Switch on/off GRE tunnel app

Status: Switch on/off someone GRE tunnel app

Name: GRE tunnel name

Through: The GRE packet transmit interface

Peer Wan IP Addr: The remote WAN address

Peer Subnet: The remote gateway local subnet, eg: 192.168.1.0/24

Peer Tunnel IP: The remote tunnel IP address

Local Tunnel IP: The local tunnel IP address

Local Netmask: Netmask of local network

Keepalive	<input checked="" type="radio"/> Enable <input type="radio"/> Disable
Retry times	<input type="text"/>
Interval	<input type="text"/>
Fail Action	Hold <input type="button" value="v"/>

Keepalive: Enable or disable GRE Keepalive function

Retry times: GRE keepalive detect fail retries

Interval: The time interval of GRE keepalive packet sent

Fail Action: The action would be exec after keeping alive failed Click on

“View GRE tunnels” keys can view the information of GRE

GRE Tunnels list

Number	Name	Enable	Through	Peer Wan IP Addr	Peer Subnet	Peer Tunnel IP	Local Tunnel IP	Local Netmask	Keepalive	Retry times	Interval	Fail Action
1	fff	Yes	PPP	120.42.46.98	192.168.5.0/24	200.200.200.1	200.200.200.5	255.255.255.0	No	0	0	Hold

3.3.5 Security

Firewall

You can enable or disable the firewall, filter specific Internet data types, and prevent anonymous Internet requests, ultimately enhance network security.

Firewall Protection



Firewall enhance network security and use SPI to check the packets into the network. To use firewall protection, choose to enable otherwise disabled. Only enable the SPI firewall, you can use other firewall functions: filtering proxy, block WAN requests, etc.

Additional Filters

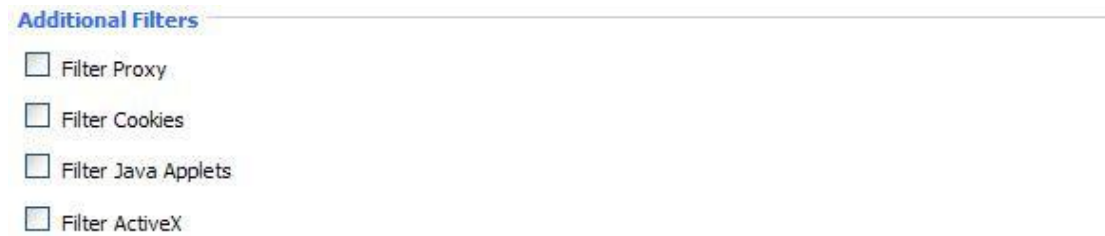

Filter Proxy: Wan proxy server may reduce the security of the gateway, Filtering Proxy will refuse any access to any wan proxy server. Click the check box to enable the function otherwise disabled.

Filter Cookies: Cookies are the website of data the data stored on your computer. When you interact with the site, the cookies will be used. Click the check box to enable the function otherwise disabled.

Filter Java Applets: If refuse to Java, you may not be able to open web pages using the Java programming. Click the check box to enable the function otherwise disabled.

Filter ActiveX: If refuse to ActiveX, you may not be able to open web pages using the ActiveX programming. Click the check box to enable the function otherwise disabled.

Prevent WAN Request



Block Anonymous WAN Requests (ping): By selecting "Block Anonymous WAN Requests (ping)" box to enable this feature, you can prevent your network

from the Ping or detection of other Internet users. so that make More difficult to break into your network. The default state of this feature is enabled ,choose to disable allow anonymous Internet requests.

Filter IDENT (Port 113): Enable this feature can prevent port 113 from being scanned from outside. Click the check box to enable the function otherwise disabled.

Block WAN SNMP Access: This feature prevents the SNMP connection requests from the WAN. After Complete the changes, click the

Save Settings: Button to save your changes. Click the

Cancel Changes: Button to cancel unsaved changes.

Impede WAN DoS/Bruteforce



Impede WAN DoS/Bruteforce

- Limit SSH Access
- Limit Telnet Access
- Limit PPTP Server Access
- Limit L2TP Server Access

Limit ssh Access: This feature limits the access request from the WAN by ssh, and per minute up to accept two connection requests on the same IP. Any new access request will be automatically dropped.

Limit Telnet Access: This feature limits the access request from the WAN by Telnet, and per minute up to accept two connection requests on the same IP. Any new access request will be automatically dropped.

Limit PPTP Server Access: When build a PPTP Server in the Router, this feature limits the access request from the WAN by ssh, and per minute up to accept two connection requests on the same IP. Any new access request will be automatically dropped.

Limit L2TP Server Access: When build a L2TP Server in the Router, this feature limits the access request from the WAN by ssh, and per minute up to accept two connection requests on the same IP. Any new access request will be automatically dropped.

Log Management

The Router can keep logs of all incoming or outgoing traffic for your Internet connection.

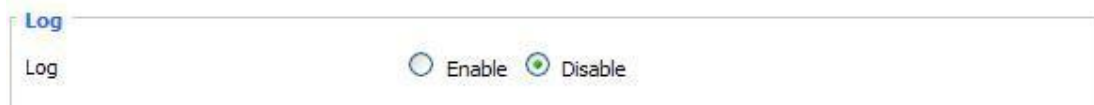

Log

Log Enable Disable

Log: To keep activity logs, select Enable. To stop logging, select Disable. When select enable, the following page will appear.

Log

Log Enable Disable

Log Level

Options

Dropped

Rejected

Accepted

Log Level: Set this to the required log level. Set Log Level higher to log more actions.

Options: When select Enable, the corresponding connection will be recorded in the journal, the disabled are not recorded.

Incoming Log: To see a temporary log of the Router's most recent incoming traffic, click the Incoming Log button.

Incoming Log Table

Source IP	Protocol	Destination Port Number	Rule
-----------	----------	-------------------------	------

Outgoing Log: To see a temporary log of the Router's most recent outgoing traffic, click the Outgoing Log button.

Outgoing Log Table

LAN IP	Destination URL/IP	Protocol	Service/Port Number	Rule
192.168.1.164	223.203.188.56	TCP	www	Accepted
192.168.1.164	183.60.16.200	UDP	8000	Accepted
192.168.1.164	183.60.48.60	UDP	8000	Accepted
192.168.1.164	112.95.240.183	UDP	8000	Accepted
192.168.1.164	183.60.49.245	UDP	8000	Accepted
192.168.1.164	119.147.32.204	UDP	8000	Accepted
192.168.1.164	112.90.86.244	UDP	8000	Accepted
192.168.1.164	119.147.45.157	UDP	8000	Accepted
192.168.1.164	183.60.49.15	UDP	8000	Accepted
192.168.1.164	183.60.16.70	UDP	8000	Accepted
192.168.1.164	183.60.16.200	UDP	8000	Accepted
192.168.1.164	183.60.48.60	UDP	8000	Accepted

Click the **Save Settings** button to save your changes. Click the **Cancel Changes** button to cancel unsaved changes.

3.3.6 Access Restrictions

WAN Access

Use access restrictions, you can block or allow specific types of Internet

applications. You can set specific PC-based Internet access policies. This feature allows you to customize up to ten different Internet Access Policies for particular PCs, which are identified by their IP or MAC addresses.

Access Policy

Policy: 1 ()

Status: Enable Disable

Policy Name:

PCs:

Deny
 Filter

Internet access during selected days and hours.

Two options in the default policy rules: "Filter" and "reject". If select "Deny", you will deny specific computers to access any Internet service at a particular time period. If you choose to "filter", It will block specific computers to access the specific sites at a specific time period. You can set up 10 Internet access policies filtering specific PCs access Internet services at a particular time period. **Access Policy:** You may define up to 10 access policies. Click Delete to delete a policy or Summary to see a summary of the policy.

Status: Enable or disable a policy.

Policy Name: You may assign a name to your policy.

PCs: The part is used to edit client list, the strategy is only effective for the PC in the list.

Days: Choose the day of the week you would like your policy to be applied.

Days

Everyday	Sun	Mon	Tue	Wed	Thu	Fri	Sat
<input checked="" type="checkbox"/>	<input type="checkbox"/>	<input type="checkbox"/>	<input type="checkbox"/>	<input type="checkbox"/>	<input type="checkbox"/>	<input type="checkbox"/>	<input type="checkbox"/>

Times

24 Hours

From 0 : 00 To 0 : 00

Times: Enter the time of the day you would like your policy to be applied.

Website Blocking by URL Address

<input type="text"/>	<input type="text"/>	<input type="text"/>
<input type="text"/>	<input type="text"/>	<input type="text"/>
<input type="text"/>	<input type="text"/>	<input type="text"/>

Website Blocking by Keyword

<input type="text"/>	<input type="text"/>	<input type="text"/>	<input type="text"/>
<input type="text"/>	<input type="text"/>	<input type="text"/>	<input type="text"/>

Website Blocking by URL Address: You can block access to certain websites by entering their URL.

Website Blocking by Keyword: You can block access to certain website by the keywords contained in their webpage

List of clients	
Enter MAC Address of the clients in this format: xx:xx:xx:xx:xx:xx	
MAC 01	<input type="text" value="00:AA:BB:CC:DD:EE"/>
MAC 02	<input type="text" value="00:00:00:00:00:00"/>
MAC 03	<input type="text" value="00:00:00:00:00:00"/>
MAC 04	<input type="text" value="00:00:00:00:00:00"/>
MAC 05	<input type="text" value="00:00:00:00:00:00"/>
MAC 06	<input type="text" value="00:00:00:00:00:00"/>
MAC 07	<input type="text" value="00:00:00:00:00:00"/>
MAC 08	<input type="text" value="00:00:00:00:00:00"/>
Enter the IP Address of the clients	
IP 01	192.168.1. <input type="text" value="15"/>
IP 02	192.168.1. <input type="text" value="0"/>
IP 03	192.168.1. <input type="text" value="0"/>
IP 04	192.168.1. <input type="text" value="0"/>
IP 05	192.168.1. <input type="text" value="0"/>
IP 06	192.168.1. <input type="text" value="0"/>
Enter the IP Range of the clients	
IP Range 01	<input type="text" value="192"/> . <input type="text" value="168"/> . <input type="text" value="1"/> . <input type="text" value="19"/> ~ <input type="text" value="192"/> . <input type="text" value="168"/> . <input type="text" value="1"/> . <input type="text" value="30"/>
IP Range 02	<input type="text" value="0"/> . <input type="text" value="0"/> . <input type="text" value="0"/> . <input type="text" value="0"/> ~ <input type="text" value="0"/> . <input type="text" value="0"/> . <input type="text" value="0"/> . <input type="text" value="0"/>

set up Internet access policy

1. Select the policy number (1-10) in the drop-down menu.
2. For this policy is enabled, click the radio button next to "Enable"
3. Enter a name in the Policy Name field.
4. Click the Edit List of PCs button.
5. On the List of PCs screen, specify PCs by IP address or MAC address. Enter the appropriate IP addresses into the IP fields. If you have a range of IP addresses to filter, complete the appropriate IP Range fields. Enter the appropriate MAC addresses into the MAC fields.
6. Click the Apply button to save your changes. Click the Cancel button to cancel your unsaved changes. Click the Close button to return to the Filters screen.
7. If you want to block the listed PCs from Internet access during the

designated days and time, then keep the default setting, Deny. If you want the listed PCs to have Internet filtered during the designated days and time, then click the radio button next to Filter.

8. Set the days when access will be filtered. Select Everyday or the appropriate days of the week.

9. Set the time when access will be filtered. Select 24 Hours, or check the box next to From and use the drop-down boxes to designate a specific time period.

10. Click the Add to Policy button to save your changes and active it.

11. To create or edit additional policies, repeat steps 1-9.

12. To delete an Internet Access Policy, select the policy number, and click the Delete button.

Note:

1. The default factory value of policy rules is "filtered". If the user chooses the default policy rules for "refuse", and editing strategies to save or directly to save the settings. If the strategy edited is the first, it will be automatically saved into the second, if not the first, keep the original number.

2. Turn off the power of the Router or reboot the Router can cause a temporary failure. After the failure of the Router, if can not automatically synchronized NTP time server, you need to recalibrate to ensure the correct implementation of the relevant period control function.

URL Filter

If you want to prevent certain client access to specific network domain name, such as www.sina.com. We can achieved it through the function of URL filter.

URL filtering function

Url Filter

Url Filter Setting

Enable Url Filter Enable Disable

Policy

Del	Num	URL
<input type="checkbox"/>	1	www.sina.com

Add Filter Rule

Type

Discard packets conform to the following rules: Only discard the matching URL address in the list.

Accept only the data packets conform to the following rules: Receive only with custom rules of network address, discarded all other URL address.

Packet Filter

Enable Packet Filter Enable Disable

Policy

To block some packets getting Internet access or block some Internet packets getting local network access, you can configure filter items to block these packets. Packet Filter Packet filter function is realized based on IP address or port of packets.

Enable Packet Filter: Enable or disable “packet filter” function

Policy: The filter rule’s policy, you can choose the following options

Discard The Following--Discard packets conform to the following rules, Accept all other packets

Only Accept The Following-- Accept only the data packets conform to the following rules, Discard all other packets

Add Filter Rule

Direction

Protocol

Source Ports -

Destination Ports -

Source IP . . . /

Destination IP . . . /

Direction

input: Packet from WAN to LAN

output: Packet from LAN to WAN

Protocol: Packet protocol type

Source Ports: Packet's source port

Destination Ports: Packet's destination port

Source IP: Packet's source IP address

Destination IP: Packet's destination IP address

Note: "Source Port" ,"Destination Port" ,"Source IP" ,"Destination IP" could not be all empty ,you have to input at least one of these four parameters.

3.3.7 NAT

Port Forwarding

Port Forwarding allows you to set up public services on your network, such as web servers, ftp servers, e-mail servers, or other specialized Internet applications. Specialized Internet applications are any applications that use Internet access to perform functions such as videoconferencing or online gaming. When users send this type of request to your network via the Internet, the Router will forward those requests to the appropriate PC. If you want to forward a whole range of ports, see Port Range Forwarding.

Application: Enter the name of the application in the field provided.

Forwards

Application	Protocol	Source Net	Port from	IP Address	Port to	Enable
web	TCP	192.168.8.11	8000	192.168.1.12	80	<input checked="" type="checkbox"/>
ftp	Both	192.168.8.12	24	192.168.1.12	21	<input checked="" type="checkbox"/>

Protocol: Chose the right protocol TCP, UDP or Both. Set this to what the application requires.

Source Net: Forward only if sender matches this IP/net (example 192.168.1.0/24).

Port from: Enter the number of the external port (the port number seen by users on the Internet).

IP Address: Enter the IP Address of the PC running the application.

Port to: Enter the number of the internal port (the port number used by the application).

Enable: Click the Enable checkbox to enable port forwarding for the application. Check all values and click **Save Settings** to save your settings. Click the **Cancel changes** button to cancel your unsaved changes.

Port Range Forward

Port Range Forwarding allows you to set up public services on your network,

such as web servers, ftp servers, e-mail servers, or other specialized Internet applications. Specialized Internet applications are any applications that use Internet access to perform functions such as videoconferencing or online gaming. When users send this type of request to your network via the Internet, the Router will forward those requests to the appropriate PC. If you only want to forward a single port, see Port Forwarding.

Application: Enter the name of the application in the field provided.

Port Range Forward

Forwards

Application	Start	End	Protocol	IP Address	Enable
web-tftp	800	8100	Both	192.168.1.16	<input checked="" type="checkbox"/>
game	9000	10000	Both	192.168.1.16	<input checked="" type="checkbox"/>

Add Remove

Start: Enter the number of the first port of the range you want to see by users on the Internet and forwarded to your PC.

End: Enter the number of the last port of the range you want to see by users on the Internet and forwarded to your PC.

Protocol: Chose the right protocol TCP, UDP or Both. Set this to what the application requires.

IP Address: Enter the IP Address of the PC running the application.

Enable: Click the Enable checkbox to enable port forwarding for the application. Check all values and click **Save Settings** to save your settings. Click the **Cancel changes** button to cancel your unsaved changes.

DMZ

The DMZ (DeMilitarized Zone) hosting feature allows one local user to be exposed to the Internet for use of a special-purpose service such as Internet gaming or video conferencing. DMZ hosting forwards all the ports at the same time to one PC. The Port Forwarding feature is more secure because it only opens the ports you want to have opened, while DMZ hosting opens all the ports of one computer, exposing the computer so the Internet can see it.

Demilitarized Zone (DMZ)

DMZ

Use DMZ Enable Disable

DMZ Host IP Address 192.168.8.

Any PC whose port is being forwarded should have a new static IP address assigned to it because its IP address may change when using the DHCP function.

DMZ Host IP Address: To expose one PC to the Internet, select Enable and enter the computer's IP address in the DMZ Host IP Address field. To disable the DMZ, keep the default setting: Disable

Check all values and click **Save Settings** to save your settings. Click the **Cancel changes** button to cancel your unsaved changes.

3.3.8 QoS Setting

Basic

Bandwidth management prioritizes the traffic on your Router. Interactive traffic (telephony, browsing, telnet, etc.) gets priority and bulk traffic (file transfer, P2P) gets low priority. The main goal is to allow both types to live side-by side without unimportant traffic disturbing more critical things. All of this is automatic.

QoS allows control of the bandwidth allocation to different services, netmasks, MAC addresses and the four LAN ports.

The image shows two identical sections of the router's QoS settings page. The top section is titled 'Main WAN QoS Settings' and the bottom section is titled 'Bkup WAN QoS Settings'. Each section contains the following fields:

- Start QoS:** Radio buttons for 'Enable' and 'Disable'. The 'Disable' option is selected in both sections.
- Port:** A dropdown menu with 'WAN' selected.
- Packet Scheduler:** A dropdown menu with 'HTB' selected.
- Uplink (kbps):** A text input field containing '0'.
- Downlink (kbps):** A text input field containing '0'.

Uplink (kbps): In order to use bandwidth management (QoS) you must enter bandwidth values for your uplink. These are generally 80% to 90% of your maximum bandwidth.

Downlink (kbps): In order to use bandwidth management (QoS) you must enter bandwidth values for your downlink. These are generally 80% to 90% of your maximum bandwidth.

Classify

Netmask Priority

Netmask Priority

Delete	IP/Mask	Priority
<input type="checkbox"/>	192.168.1.1/24	Exempt
<input type="checkbox"/>	192.168.2.3/24	Standard
<input type="checkbox"/>	192.168.3.4/32	Express
<input type="checkbox"/>	192.168.4.5/32	Bulk

... /

You may specify priority for all traffic from a given IP address or IP Range. Check all values and click **Save Settings** to save your settings. Click the **Cancel changes** button to cancel your unsaved changes.

3.3.9 Applications

Serial Applications

There is a console port on router. Normally, this port is used to debug the router. This port can also be used as a serial port. The router has embedded a serial to TCP program. The data sent to the serial port is encapsulated by TCP/IP protocol stack and then is sent to the destination server. This function can work as a DTU (Data Terminal Unit).

Serial Applications

Serial Applications Enable Disable

Baudrate

Databit

Stopbit

Parity

Flow Control

Protocol

Server Address

Server Port

Device Number

Device Id

Heartbeat Interval

Baudrate: Baud rate indicates the number of bytes per second transported by device, commonly used baud rate is 115200, 57600, 38400, 19200.

Databit: The data bits can be 4, 5, 6, 7, 8, constitute a character. The ASCII code is usually used. Starting from the most significant bit is transmitted.

Stopbit: it marks the end of a character data. It is a high level of 1, 1.5, 2.

Parity: use a set of data to check the data error.

Flow control: including the hardware part and software part in two ways.

Enable Serial TCP Function: Enable the serial to TCP function

Protocol Type: The protocol type to transmit data.

UDP(DTU) – Data transmit with UDP protocol, work as a Proroute IP MODEM device which has application protocol and hear beat mechanism.

Pure UDP – Data transmit with standard UDP protocol.

TCP(DTU) -- Data transmit with TCP protocol, work as a Proroute IP MODEM device which has application protocol and hear beat mechanism.

Pure TCP -- Data transmit with standard TCP protocol, router is the client.

TCP Server -- Data transmit with standard TCP protocol, router is the server.

TCST -- Data transmit with TCP protocol, Using a custom data

Server Address: The data service center's IP Address or domain name.

Server Port: The data service center's listening port.

Device ID: The router's identity ID.

Device Number: The Router's phone number.

Heartbeat Interval: The time interval to send heartbeat packet. This item is valid only when you choose UDP(DTU) or TCP(DTU) protocol type.

TCP Server Listen Port: This item is valid when Protocol Type is "TCP Server"

Custom Heartbeat Packet: This item is valid when Protocol Type is "TCST"

Custom Registration Packets: This item is valid when Protocol Type is "TCST"

3.3.10 Administration

Management

The Management screen allows you to change the Router's settings. On this page you will find most of the configurable items of the router code.

Router Password

Router Username	<input type="password"/>
Router Password	<input type="password"/>
Re-enter to confirm	<input type="password"/>

The new password must not exceed 32 characters in length and must not include any spaces. Enter the new password a second time to confirm it.

Note:

Default username is admin.

It is strongly recommended that you change the factory default password of the router, which is admin. All users who try to access the Router's web-based utility or Setup Wizard will be prompted for the router's password.

Web Access

This feature allows you to manage the router using either HTTP protocol or the HTTPS protocol. If you choose to disable this feature, a manual reboot will be required. You can also activate or not the router information web page. It's now possible to password protect this page (same username and password than above).

Protocol : This feature allows you to manage the Router using either HTTP protocol or

Web Access

Protocol	<input checked="" type="checkbox"/> HTTP <input type="checkbox"/> HTTPS
Auto-Refresh (in seconds)	<input type="text" value="3"/>
Enable Info Site	<input checked="" type="radio"/> Enable <input type="radio"/> Disable
Info Site Password Protection	<input type="checkbox"/> Enabled

the HTTPS protocol

Auto-Refresh: Adjusts the Web GUI automatic refresh interval. 0 disables this feature completely

Enable Info Site: Enable or disable the login system information page

Info Site Password Protection: Enable or disable the password protection feature of the system information page

Remote Access

Web GUI Management	<input checked="" type="radio"/> Enable <input type="radio"/> Disable	
Use HTTPS	<input type="checkbox"/>	
Web GUI Port	<input type="text" value="8080"/>	(Default: 8080, Range: 1 - 65535)
SSH Management	<input checked="" type="radio"/> Enable <input type="radio"/> Disable	
SSH Remote Port	<input type="text" value="22"/>	(Default: 22, Range: 1 - 65535)
Telnet Management	<input type="radio"/> Enable <input checked="" type="radio"/> Disable	

Remote Access: This feature allows you to manage the Router from a remote location, via the Internet. To disable this feature, keep the default setting, Disable. To enable this feature, select Enable, and use the specified port (default is 8080) on your PC to remotely manage the Router. You must also change the Router's default password to one of your own, if you haven't already.

To remotely manage the Router, enter `http://xxx.xxx.xxx.xxx:8080` (the x's represent the Router's Internet IP address, and 8080 represents the specified port) in your web browser's address field. You will be asked for the Router's password.

If you use https you need to specify the URL as `https://xxx.xxx.xxx.xxx:8080` (not all firmware does support this without rebuilding with SSL support).

SSH Management: You can also enable SSH to remotely access the Router by Secure Shell. Note that SSH daemon needs to be enable in Services page.

Note:

If the Remote Router Access feature is enabled, anyone who knows the Router's Internet IP address and password will be able to alter the Router's settings.

Telnet Management: Enable or disable remote Telnet function

Cron

Cron	<input checked="" type="radio"/> Enable <input type="radio"/> Disable
Additional Cron Jobs	<input type="text"/>

Cron: The cron subsystem schedules execution of Linux commands. You'll need to use the command line or startup scripts to use this.

Language Selection

Language	<input type="text" value="English"/>
----------	--------------------------------------

Language: Set up the Router page shows the type of language, including simplified Chinese and English.

Device Management

Device Management Enable Disable

Device Management Server IP

Device Management Server Listen Port (Default: 40001, Range: 1 - 65535)

Heart Interval (Default: 60Sec, Range: 1 - 999)

Device Number

Device Phone Number

Device Type Description

Remote Upgrade: Custom-developed remote management server for this station router monitoring and management, configuration parameters, WIFI advertising updates.

Keep Alive

Schedule Boot & Shutdown

Schedule Boot&Shutdown

Schedule Boot&Shutdown Enable Disable

Match Day Weekday Days Weekdays

Shutdown Time :

Shutdown Date - - -

Boot Time :

Boot Date - - -

The user can set the startup or shutdown time:

For example, the user wants to set the start time at 8:07 and boot time at 9:07.

Schedule Boot&Shutdown

Schedule Boot&Shutdown Enable Disable

Match Day Weekday Days Weekdays

Shutdown Time :

Shutdown Date - - -

Boot Time :

Boot Date - - -

Schedule Reboot

Schedule Reboot

Schedule Reboot Enable Disable

Interval (in seconds)

At a set Time :

You can schedule regular reboots for the router:

- Regularly after xxx seconds.
- At a specific date time each week or every day.

Note:

For date-based reboots Cron must be activated. See Management for Cron activation.

Commands

Commands: You can run command lines directly via the Web interface.

Command Shell

Commands

Run Command: You can run command lines via the web interface. Fill the text area with your command and click Run Commands to submit.

Startup: You can save some command lines to be executed at startup's Router. Fill the text area with commands (only one command by row) and click Save Startup.

Shutdown: You can save some command lines to be executed at shutdown's Router. Fill the text area with commands (only one command by row) and click Save Shutdown.

Firewall: Each time the firewall is started, it can run some custom iptables instructions. Fill the text area with firewall's instructions (only one command by row) and click Save Firewall.

Custom Script: Custom script is stored in /tmp/custom.sh file. You can run it manually or use cron to call it. Fill the text area with script's instructions (only one command by row) and click Save Custom Script.

Factory Defaults

Factory Defaults

Reset router settings

Restore Factory Defaults Yes No

Reset Router Settings: Click the Yes button to reset all configuration settings to their default values. Then click the Apply Settings button.

Note:

Any settings you have saved will be lost when the default settings are restored. After restoring the Router is accessible under the default IP address 192.168.1.1 and the default password admin.

Firmware Upgrade

Firmware Upgrade

After flashing, reset to

Please select a file to upgrade

Firmware Upgrade: New firmware versions are posted at www..com and can be downloaded. If the Router is not experiencing difficulties, then there is no need to download a more recent firmware version, unless that version has a new feature that you want to use.

Note:

When you upgrade the Router's firmware, you lose its configuration settings, so make sure you write down the Router settings before you upgrade its firmware.

To upgrade the router's firmware:

1. Download the firmware upgrade file from the website.
2. Click the Browse... button and chose the firmware upgrade file.
3. Click the Upgrade button and wait until the upgrade is finished.

Note:

Upgrading firmware may take a few minutes.

Do not turn off the power or press the reset button!

After flashing, reset to: If you want to reset the Router to the default settings for the firmware version you are upgrading to, click the Firmware Defaults option.

Backup

Backup Configuration

Backup Settings

Click the "Backup" button to download the configuration backup file to your computer.

Restore Configuration

Restore Settings

Please select a file to restore

WARNING

Only upload files backed up using this firmware and from the same model of router.
Do not upload any files that were not created by this interface!

Backup Settings: You may backup your current configuration in case you need to reset the Router back to its factory default settings. Click the Backup button to back up your current configuration.

Restore Settings: Click the Browse... button to browse for a configuration file that is currently saved on your PC. Click the Restore button to overwrite all current configurations with the ones in the configuration file.

Note:

Only restore configurations with files backed up using the same firmware and the same model of Router.

3.3.11 Status

Router

System	
Router Name	Proroute RAPID
Router Model	NR550
Firmware Version	F000X v1.0 (01/10/12) std - build 94
MAC Address	<u>00:AA:BB:CC:DD:44</u>
Host Name	
WAN Domain Name	
LAN Domain Name	
Current Time	Sat, 01 Jan 2000 00:51:29
Uptime	51 min,

Router Name: Name of the router, setting basic setting to modify

Router Model: Model of the Router, unavailable to modify

Firmware Version: software version information

MAC Address: MAC address of WAN, setting Clone MAC Address to modify

Host Name: Host name of the Router, setting basic setting to modify

WAN Domain Name: Domain name of WAN, setting basic setting to modify

LAN Domain Name: Domain name of LAN, unavailable to modify

Current Time: Local time of the system

Uptime: Operating uptime as long as the system is powered on



Total Available: The room for total available of RAM (that is physical memory minus some reserve and the kernel of binary code bytes)

Free: Free memory, the router will reboot if the memory is less than 500kB

Used: Used memory, total available memory minus free memory

Buffers: Used memory for buffers,

Cached: The memory used by high-speed cache memory

Active: Active use of buffer or cache memory page file size

Inactive: Not often used in a buffer or cache memory page file size



IP Filter Maximum Ports: Preset is 4096, available to re-management

Active IP Connections: Real time monitor active IP connections of the system, click to see the table as blow:

No.	Protocol	Timeout (s)	Source Address	Remote Address	Service Name	State
1	TCP	60	192.168.1.120	192.168.1.1	80	TIME_WAIT
2	TCP	30	192.168.1.120	192.168.1.1	80	TIME_WAIT
3	TCP	65	192.168.1.120	192.168.1.1	80	TIME_WAIT
4	TCP	96	192.168.1.120	192.168.1.1	80	TIME_WAIT
5	TCP	99	192.168.1.120	192.168.1.1	80	TIME_WAIT
6	TCP	70	192.168.1.120	192.168.1.1	80	TIME_WAIT
7	TCP	74	192.168.1.120	192.168.1.1	80	TIME_WAIT
8	TCP	115	192.168.1.120	192.168.1.1	80	TIME_WAIT
9	TCP	84	192.168.1.120	192.168.1.1	80	TIME_WAIT
10	TCP	3599	192.168.1.120	192.168.1.1	80	ESTABLISHED
11	TCP	3599	192.168.1.120	192.168.1.1	80	ESTABLISHED
12	TCP	108	192.168.1.120	192.168.1.1	80	TIME_WAIT
13	TCP	3600	192.168.1.120	192.168.1.1	80	ESTABLISHED
14	TCP	93	192.168.1.120	192.168.1.1	80	TIME_WAIT
15	TCP	102	192.168.1.120	192.168.1.1	80	TIME_WAIT
16	TCP	74	192.168.1.120	192.168.1.1	80	TIME_WAIT
17	TCP	3599	192.168.1.120	192.168.1.1	80	ESTABLISHED
18	TCP	15	192.168.1.120	192.168.1.1	80	TIME_WAIT
19	TCP	25	192.168.1.120	192.168.1.1	80	TIME_WAIT
20	TCP	90	192.168.1.120	192.168.1.1	80	TIME_WAIT
21	UDP	26	192.168.8.119	255.255.255.255	1947	UNREPLIED
22	TCP	77	192.168.1.120	192.168.1.1	80	TIME_WAIT
23	TCP	35	192.168.1.120	192.168.1.1	80	TIME_WAIT
24	TCP	74	192.168.1.120	192.168.1.1	80	TIME_WAIT
25	TCP	40	192.168.1.120	192.168.1.1	80	TIME_WAIT
26	TCP	3599	192.168.1.120	192.168.1.1	80	ESTABLISHED
27	TCP	74	192.168.1.120	192.168.1.1	80	TIME_WAIT
28	TCP	74	192.168.1.120	192.168.1.1	80	TIME_WAIT
29	TCP	4	192.168.1.120	192.168.1.1	80	TIME_WAIT
30	UDP	31	192.168.8.160	224.0.0.1	9166	UNREPLIED
31	TCP	74	192.168.1.120	192.168.1.1	80	TIME_WAIT

Active IP Connections: Total active IP connections

Protocol: Connection protocol

Timeouts: Connection timeouts, unit is second

Source Address: Source IP address

Remote Address: Remote IP address

Service Name: Connecting service port

Status: Displayed status

WAN

Connection Type Automatic Configuration - DHCP

Connection Uptime Not available

Connection Type: Disabled, static IP, automatic configuration-DHCP, PPPOE, PPTP, L2TP, 3G/UMTS

Connection Uptime: Connecting uptime; If disconnect, display Not available

IP Address 0.0.0.0

Subnet Mask 0.0.0.0

Gateway 0.0.0.0

DNS 1

DNS 2

DNS 3

IP Address: IP address of router WAN

Subnet Mask: Subnet mask of router WAN

Gateway: The gateway of router WAN

DNS1, DNS2, DNS3: DNS1/DNS2/DNS3 of Router WAN

Remaining Lease Time	0 days 23:38:43
<input type="button" value="DHCP Release"/> <input type="button" value="DHCP Renew"/>	

Remaining Lease Time: Remaining lease time of IP address in DHCP way

DHCP Release: Release DHCP address

DHCP Renew: Renew IP address in DHCP way, default is 1 day

Login Status	Disconnected <input type="button" value="Connect"/>
--------------	---

Login Status: Connection status of WAN

Disconnection: Disconnect

Connection: Connect

Module Type	ZTE-EVDO MODULE
	
Signal Status	-79 dBm
Network	CDMA/HDR

Module Type: Module type in 3G/UMTS way

Signal Status: Signal intensity of the module in 3G/UMTS way

Network: Network type of the module in 3G/UMTS way

Total Traffic

Incoming (MBytes)	0
Outgoing (MBytes)	0

Traffic by Month

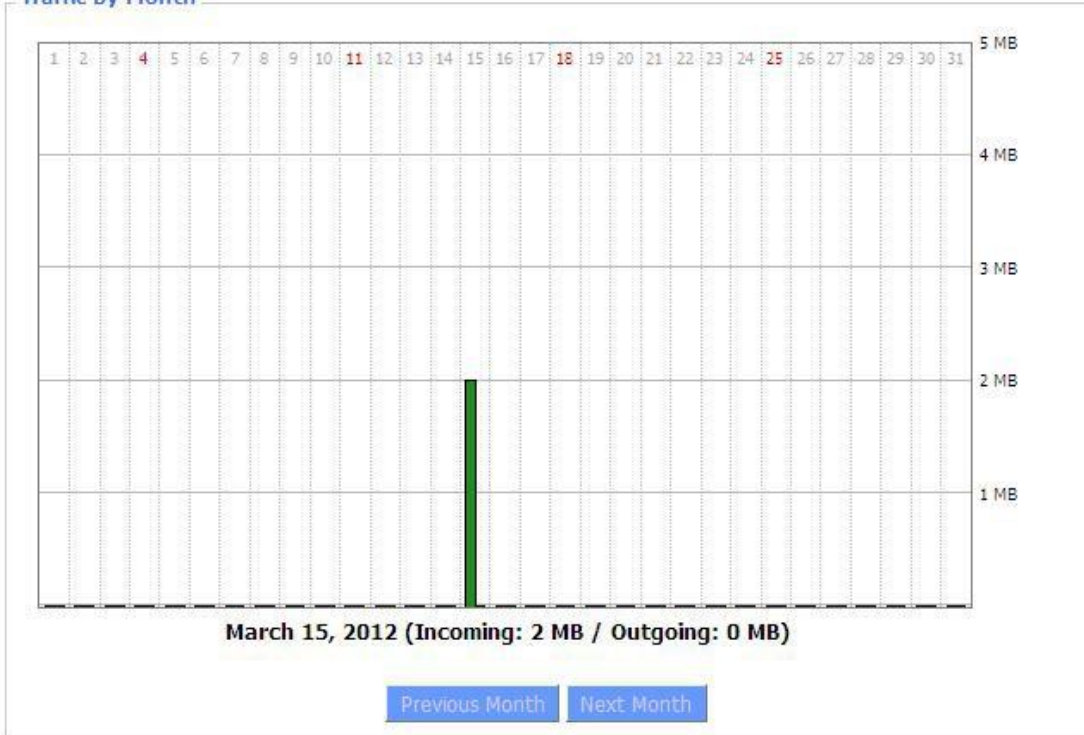

Total Flow: Flow from power-off last time until now statistics, download and upload direction

Monthly Flow: The flow of a month, unit is MB

Last Month: The flow of last month

Next Month: The flow of next month

Data Administration

[Backup](#) [Restore](#) [Delete](#)

Backup: Backup data administration

Restore: Restore data administration

Delete: Delete data administration

LAN

LAN Status

MAC Address	<u>00:0C:43:30:52:77</u>
IP Address	192.168.1.1
Subnet Mask	255.255.255.0
Gateway	0.0.0.0
Local DNS	0.0.0.0

MAC Address: MAC Address of the LAN port ethernet

IP Address: IP Address of the LAN port

Subnet Mask: Subnet Mask of the LAN port

Gateway: Gateway of the LAN port

Local DNS: DNS of the LAN port

Active Clients

Host Name	IP Address	MAC Address	Conn. Count	Ratio [4096]
*	192.168.1.120	<u>10:78:D2:98:C9:46</u>	57	1%

Host Name: Host name of LAN client

IP Address: IP address of the client

MAC Address: MAC address of the client

Conn. Count: Connection count caused by the client

Ratio: The ratio of 4096 connection

Dynamic Host Configuration Protocol

DHCP Status

DHCP Server	Enabled
DHCP Daemon	uDHCpd
Start IP Address	192.168.1.100
End IP Address	192.168.1.149
Client Lease Time	1440 minutes

DHCP Server: Enable or disable the Router work as a DHCP server

DHCP Daemon: The agreement allocated using DHCP including DNSMasq and uDHCpd Starting IP

Address: The starting IP Address of the DHCP server's Address pool

Ending IP Address: The ending IP Address of the DHCP server's Address pool

Client Lease Time: The lease time of DHCP client

DHCP Clients

Host Name	IP Address	MAC Address	Client Lease Time	Delete
PC-201011161332	192.168.1.142	<u>00:21:5C:33:4D:29</u>	1 day 00:00:00	
jack-lincw	192.168.1.117	<u>44:37:E6:3F:45:54</u>	1 day 00:00:00	
*	192.168.1.149	<u>00:0C:E7:00:00:00</u>	1 day 00:00:00	

Host Name: Host name of LAN client
IP Address: IP address of the client
MAC Address: MAC address of the client
Expires: The expiry the client rents the IP address

Connected PPPOE Clients

Interface	User Name	Local IP	Delete
ppp0	hometest	192.168.10.10	

Delete: Click to delete DHCP client
Interface: The interface assigned by dial-up system
Username: Username of PPPoE client
Local IP: IP address assigned by PPPoE client
Delete: Click to delete PPPoE client

Connected L2TP Server

Interface	Local IP	Remote IP	Delete
ppp0	172.168.8.2	172.168.8.1	

Interface: The interface assigned by dial-up system
Local IP: Tunnel IP address of local L2TP
Remote IP: Tunnel IP address of L2TP server
Delete: Click to disconnect L2TP

Connected L2TP Clients

Interface	User Name	Local IP	Remote IP	Delete
ppp1	hometest	192.168.50.2	120.42.46.98	

Interface: The interface assigned by dial-up system
Username: Username of the client
Local IP: Tunnel IP address of L2TP client
Remote IP: IP address of L2TP client
Delete: Click to delete L2TP client

Connected PPTP Server

Interface	Local IP	Remote IP	Delete
ppp0	172.168.8.2	172.168.8.1	

Interface: The interface assigned by dial-up system
Local IP: Tunnel IP address of local PPTP
Remote IP: Tunnel IP address of PPTP server
Delete: Click to disconnect PPTP

Connected PPTP Clients

Interface	User Name	Local IP	Remote IP	Delete
ppp1	hometest	192.168.5.1	120.42.46.98	

Interface: The interface assigned by dial-up system

Username: Username of the client

Local IP: Tunnel IP address of PPTP client

Remote IP: IP address of PPTP client

Delete: Click to delete PPTP client

Wireless

Wireless Status

MAC Address	00:0C:43:30:52:79
Radio	Radio is On
Mode	AP
Network	Mixed
SSID	NR550
Channel	6 (2437 MHz)
TX Power	71 mW
Rate	72 Mb/s
Encryption - Interface wlo	Disabled
PPTP Status	Disconnected

MAC Address: MAC address of wireless client

Radio: Display whether radio is on or not

Mode: Wireless mode

Network: Wireless network mode

SSID: Wireless network name

Channel: Wireless network channel

TX Power: Reflection power of wireless network

Rate: Reflection rate of wireless network

Encryption-Interface wlo: Enable or diasbal Encryption-Interface wlo

PPTP Status: Show wireless pptp status

Wireless Packet Info

Received (RX)	91125 OK, no error	100%
Transmitted (TX)	11957 OK, no error	100%

Received (RX): Received data packet

Transmitted (TX): Transmitted data packet

Wireless Nodes								
Clients								
MAC Address	Interface	Uptime	TX Rate	RX Rate	Signal	Noise	SNR	Signal Quality
- None -								

MAC Address: MAC address of wireless client

Interface: Interface of wireless client

Uptime: Connecting uptime of wireless client

TX Rate: Transmit rate of wireless client

RX Rate: Receive rate of wireless client

Signal: The signal of wireless client

Noise: The noise of wireless client

SNR: The signal to noise ratio of wireless client

Signal Quality: Signal quality of wireless client

Neighbor's Wireless Networks											
SSID	Mode	MAC Address	Channel	Rssi	Noise	beacon	Open	dtim	Rate	Join Site	
ttt-3g	Unknown	00:22:3b:cc:cd:14	2	-5	-95	0	Yes	0	54(b/g)	Join	
proroute	Unknown	00:1c:43:30:32:29	6	-24	-95	0	Yes	0	300(b/g/n)	Join	
tt-old	AP	00:13:10:09:56:02	6	-55	-95	0	Yes	0	54(b/g)	Join	

Neighbor's Wireless Network: Display other networks nearby

SSID: The name of wireless network nearby

Mode: Operating mode of wireless network nearby

MAC Address: MAC address of the wireless nearby

Channel: The channel of the wireless nearby

Rssi: Signal intensity of the wireless nearby

Noise: The noise of the wireless nearby

Beacon: Signal beacon of the wireless nearby

Open: The wireless nearby is open or not

Dtim: Delivery traffic indication message of the wireless nearby

Rate: Speed rate of the wireless nearby

Join Site: Click to join wireless network nearby

Bandwidth



Bandwidth Monitoring-LAN Graph

Abscissa axis: Time

Vertical axis: Speed rate

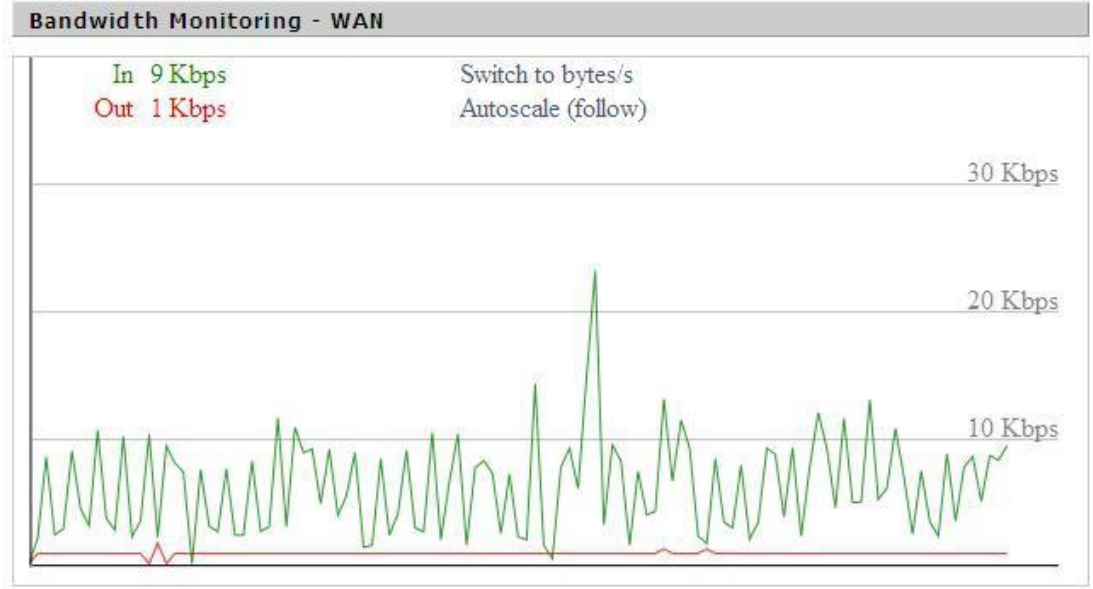

Bandwidth Monitoring-WAN Graph

Abscissa axis: Time

Vertical axis: Speed rate

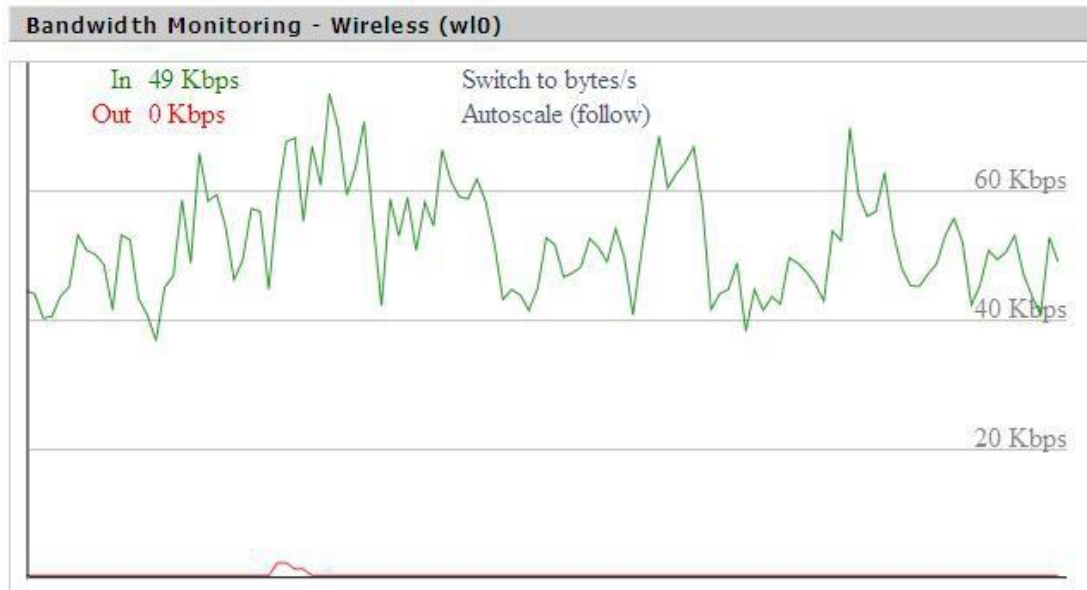

Bandwidth Monitoring-Wireless (W10) Graph

Abscissa axis: Time

Vertical axis: Speed rate

Sys-Info

Router	
Router Name	Proroute RAPID
Router Model	NR550
LAN MAC	<u>00:0C:43:30:52:77</u>
WAN MAC	<u>00:0C:43:30:52:78</u>
Wireless MAC	<u>00:0C:43:30:52:79</u>
WAN IP	10.34.107.156
LAN IP	192.168.8.1

Router Name: The name of the Router

Router Model: The model of the Router

LAN MAC: MAC address of LAN port

WAN MAC: MAC address of WAN port

Wireless MAC: MAC address of the wireless

WAN IP: IP address of WAN port

LAN IP: IP address of LAN port

Wireless	
Radio	Radio is On
Mode	AP
Network	Mixed
SSID	NR550
Channel	6 (2437 MHz)
TX Power	71 mW
Rate	72 Mb/s

Radio: Display whether radio is on or not

Mode: Wireless mode

Network: Wireless network mode

SSID: Wireless network name

Channel: Wireless network channel

TX Power: Reflection power of wireless network

Rate: Reflection rate of wireless network

Wireless Packet Info	
Received (RX)	6982 OK, no error
Transmitted (TX)	1498 OK, no error

Received (RX): Received data packet

Transmitted (TX): Transmitted data packet

Wireless								
Clients								
MAC Address	Interface	Uptime	TX Rate	RX Rate	Signal	Noise	SNR	Signal Quality
- None -								

MAC Address: MAC address of wireless client

Interface: Interface of wireless client

Uptime: Connecting uptime of wireless client

TX Rate: Transmit rate of wireless client

RX Rate: Receive rate of wireless client

Signal: The signal of wireless client

Noise: The noise of wireless client

SNR: The signal to noise ratio of wireless client

Signal Quality: Signal quality of wireless client

Services

DHCP Server	Enabled
ff-radauth	Disabled
USB Support	Disabled

DHCP Server: Enabled or disabled

ff-radauth: Enabled or disabled

Memory

Total Available	122.3 MB / 128.0 MB
Free	92.6 MB / 122.3 MB
Used	29.6 MB / 122.3 MB
Buffers	3.3 MB / 29.6 MB
Cached	11.7 MB / 29.6 MB
Active	10.3 MB / 29.6 MB
Inactive	6.4 MB / 29.6 MB

USB Support: Enabled or disabled

Total Available: The room for total available of RAM (that is physical memory minus some reserve and the kernel of binary code bytes)

Free: Free memory, the Router will reboot if the memory is less than 500kB

Used: Used memory, total available memory minus free memory

Buffers: Used memory for buffers, total available memory minus allocated memory

Cached: The memory used by high-speed cache memory

Active: Active use of buffer or cache memory page file size

Inactive: Not often used in a buffer or cache memory page file size

DHCP

DHCP Clients

Host Name	IP Address	MAC Address	Expires
*	192.168.1.143	xx:xx:xx:xx:DD:45	1 day 00:00:00
four-488e1df5fa	192.168.1.125	xx:xx:xx:xx:D8:F7	1 day 00:00:00
Mycenae-PC	192.168.1.116	xx:xx:xx:xx:5E:30	1 day 00:00:00

Host Name: Host name of LAN client

IP Address: IP address of the client

MAC Address: MAC address of the client

Expires: The expiry the client rents the IP address

Appendix

The following steps describe how to setup Windows XP Hyper Terminal.

1. Press Start → Programs → Accessories → Communications → Hyper Terminal

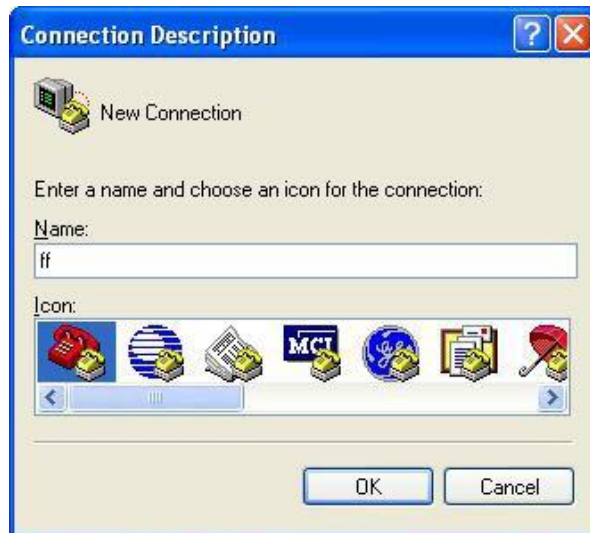

2. Input connection name, choose “OK”

3. Choose the correct COM port which connects to modem, choose “OK”



4. Configure the serial port parameters as following, choose “OK” Bits per

Second: 115200

Data bits: 8

Parity: None Stop
bits: 1
Flow control: None

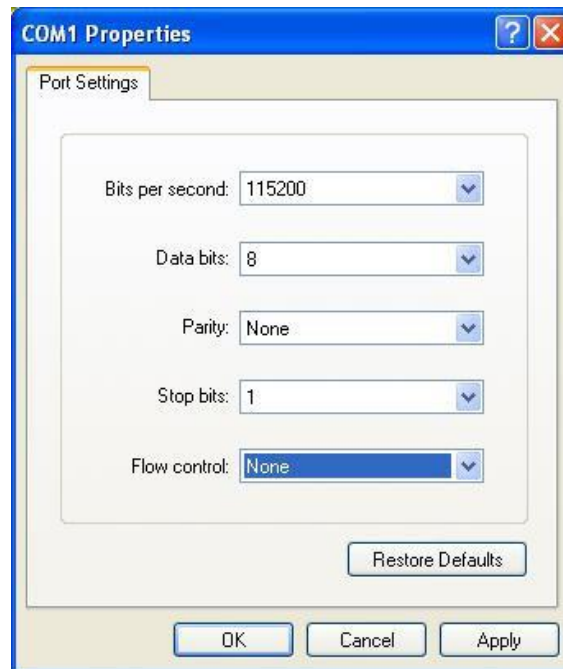

5. Complete Hyper Terminal operation, it runs as following

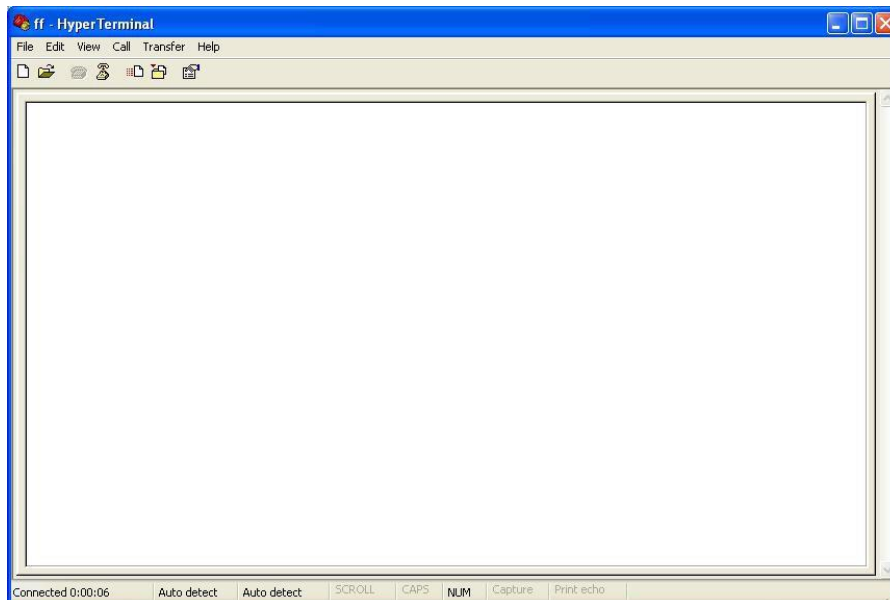

Note: If the user is using the win7 system, you can download a win7 super terminal on the internet. Universal serial interface or other similar software.