



R2110 robustOS

High Speed Smart LTE/LTE-A Router
4 Eth + 1 RS232 + 1 RS485 + Bluetooth



INTRODUCTION

The Robustel High Speed Smart LTE/LTE-A Router (R2110) is a rugged cellular router offering state-of-the-art mobile connectivity for internet of things applications.

R2110 is a powerful platform developed based on **RobustOS**, a Robustel self-developed and Linux-based operating system which is designed to be used in Robustel devices. The RobustOS includes basic networking features and protocols providing customers with excellent user experience. Meanwhile, RobustOS offers **Software Development Kit (SDK)** allows partners and customers to develop IoT applications by using C, C++. It also provides various **Apps** to meet fragmented IoT market demands.

RCMS is Robustel's free router monitoring service that is fully compatible with the R2110. It allows customer to see a location overview of their routers quickly and simply on a map. Features such as data usage, signal strength, current network and much more can then be viewed on a per router basis. Over-the-air updates are supported for Firmware, router configuration and Apps serving as essential 'insurance' if anything was not quite right during deployment.

You can try Robustel's free router management platform by signing up here: <https://rcms-cloud.robustel.net>

KEY FEATURES

- Supports WWAN, WAN, WLAN link backup and ICMP detection
- Supports cold backup, warm backup and load balancing
- RobustOS + SDK + App
- IPSec/OpenVPN/GRE
- Ignition sensing (optional)
- Management and maintenance via Web/CLI/SNMP/RCMS
- Robust industrial design (desktop or wall mounting or DIN rail mounting)



APPLICATION EXAMPLE

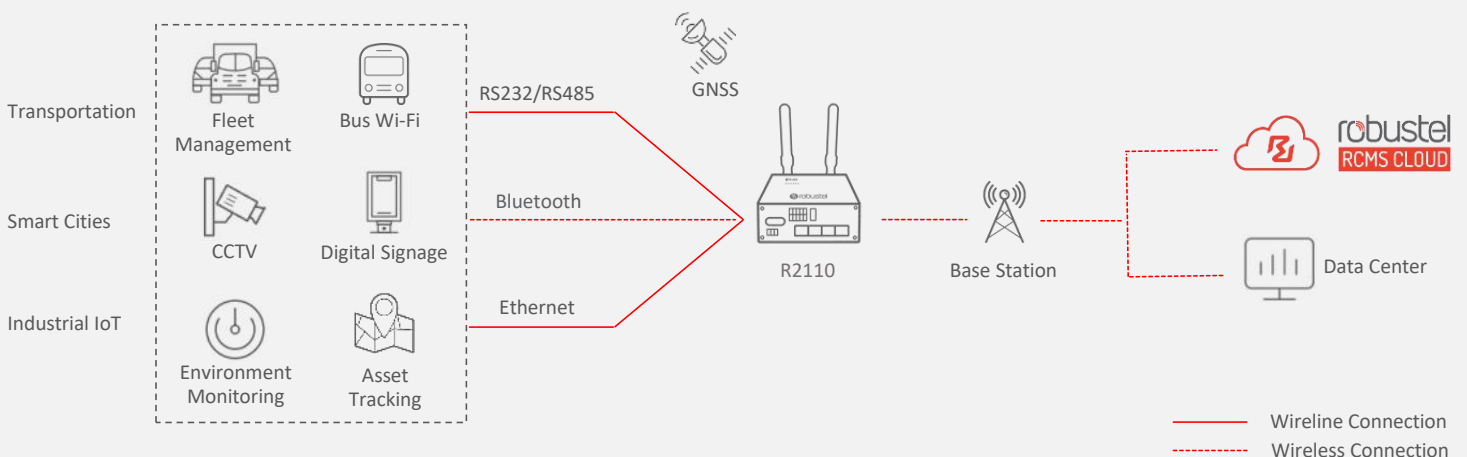

SPECIFICATIONS

Cellular Interface

Number of antennas	2 (MAIN + AUX)
Connector	SMA-K
SIM	2 Mini SIM (2FF)

Ethernet Interface

LAN port	3 x LAN (10/100/1000 Mbps)
WAN port	Support 802.3at PD feature on ETH0 1 x WAN (10/100/1000 Mbps)

Magnet isolation protection	1 KV
-----------------------------	------

Wi-Fi Interface

Number of antennas	2
Connector	RP-SMA-K
Standards	802.11 a/b/g/n/ac, 2 x 2 MIMO, support AP and client modes
Frequency bands	2.412 ~ 2.472 GHz (2.4 GHz ISM band) 5.15 ~ 5.825 GHz (5 GHz ISM band)
Security	Open, WPA, WPA2, WEP
Encryption	AES, TKIP, WEP64
Data speed	5G: Up to 867 Mbps 2.4G: Up to 300 Mbps

Bluetooth Interface (Optional)

Number of antennas	1
Connector	RP-SMA-K
Standards	BLE 5.0, Compatible with BLE 4.2/BLE 4.0

GNSS (Optional)

Number of antennas	1
GNSS technology	GPS/QZSS/GOLNASS/Galileo/BeiDou
Connector	SMA-K with 50 ohms impedance
Tracking sensitivity	GNSS: greater than -148 dBm
Horizontal position accuracy	GNSS: 2.5 m

Serial Interface

Number of ports	1 x RS232 + 1 x RS485
Connector	2 x 3-pin 3.5 mm female socket
ESD protection	±15 KV
Baud rate	300 bps ~ 115200 bps

DI/DO

Type	1x DI + 1 x DO, wet contact
Connector	2 x 2-pin 3.5 mm female socket
Isolation	3.75 KVDC
Absolute maximum VDC	"V+" +30 VDC (DI), +30 VDC (DO)
Absolute maximum ADC	100 mA

Others

Reset button	1 x RST
SD	1 x Micro SD
Expansion	1 x USB2.0 Host, 5V/500mA
LED indicators	1 x RUN, 1 x Modem, 1 x USR, 1 x RSSI, 1 x NET, 1 x Wi-Fi
Built-in	Watchdog

Software (Basic features of RobustOS)

Network protocols	PPP, PPPoE, TCP, UDP, DHCP, ICMP, NAT, HTTP, HTTPS, DNS, ARP, NTP, SMTP, Telnet, SSH2, DDNS, etc.
VPN tunnel	IPSec, OpenVPN, GRE
Firewall	DMZ, anti-DoS, Filtering (IP/Domain name/MAC address), Port Mapping, Access Control
Remote management	Web, CLI, SMS
Serial port	Transparent, TCP Client/Server, UDP, Modbus RTU to TCP

App Center (Available apps for RobustOS)

Apps*	L2TP, PPTP, DMVPN, VRRP, QoS, SNMP, Language, RCMS, Bluetooth, Dynamic Route Data Guard
-------	---

*Request on demand. For more Apps please visit www.robustel.com.

SDK

Supported programming language	C, C++
Flash available for SDK	5 MB
RAM available for SDK	256 MB

Power Supply and Consumption

Connector	3-pin 3.5 mm female socket with lock
Input voltage	9 ~ 36 VDC (POE-PD) 10 ~ 30 VDC (ACC)
Power consumption	Idle: 500 mA@12 V Data link: 1.3 A (peak) @12 V

Physical Characteristics

Ingress protection	IP30
Housing & Weight	Aluminum, 500 g
Dimension	125 x 100 x 48 mm
Installations	Desktop, wall mounting and DIN rail mounting
Operating temperature	Normal operation: -20 ~ +55 °C Extended operation: -25 ~ +70 °C
Storage temperature	-40 ~ +85 °C
Relative humidity	5 ~ 95% RH

Regulatory and Type Approvals

Environmental	RoHS2.0, WEEE
---------------	---------------

ORDERING INFORMATION

Model	PN	Category	BLE	GNSS	ACC	POE	Frequency Bands	Country /Region	Certifications (*In progress)
R2110-4L	B044702	Cat 6	-	-	-	✓	4G: LTE FDD: B1/B3/B5/B7/B8/B18/B19/B21/B28 LTE TDD: B38/B39/B40/B41	Oceania	Telstra, RCM
	B044714		✓	✓	-	✓	3G: UMTS/HSPA+: B1/B5/B6/B8/B9/B19 TD SCDMA: B39		
	B044715	Cat 6	-	-	-	✓	4G: LTE FDD: B1/B3/B5/B7/B8/B18/B19/B20/B26/B28/B28A LTE TDD: B38/B39/B40/B41 3G: TD SCDMA: B34/B39 UMTS/HSPA+: 850/900/1800/2100 MHz 2G: GSM/GPRS/EDGE: 900/1800 MHz	EMEA	CE, E-13
	B044719		✓	-	-	✓			
	B044720		✓	✓	✓	-			
	B044730		-	-	-	✓			
	B044733	Cat 4	✓	-	-	✓	4G: LTE FDD: B1/B2/B3/B4/B5/B7/B8/B12/B13/B18/B19/B20/B25/B26/B28 LTE TDD: B38/B39/B40/B41 3G: WCDMA: B1/B2/B4/B5/B6/B8/B19 2G: GSM: B2/B3/B5/B8	Oceania EMEA	E-13, CE, RCM ICASA
	B044734		✓	✓	✓	-			
	B044735	Cat 4	✓	✓	-	✓	4G: LTE FDD: B1/B3/B8/B18/B19/B26 LTE TDD: B41 3G: WCDMA: B1/B6/B8/B19	Japan	Telec, JATE
	B044736		✓	-	✓	-			
B044737	-		-	-	✓				
B044738	✓		-	-	✓				

*For more information about frequency bands in different countries, please contact your Robustel sales representative.